

NARDI
YOUR OUTDOOR LIVING

outdoor

outdoor
design Raffaello Galiotto

Interpretare la voglia di vivere all'aria aperta, proporre prodotti con forme e colori brillanti e seducenti. Da più di 25 anni Nardi rappresenta in modo contemporaneo le scenografie del vivere open air. Per star bene e far star bene gli altri. Nardi #feelingbetter

An expression of the desire to live life outdoors, offering products with bright and seductive shapes and colours. For more than 25 years, Nardi has been providing modern, open air living solutions. Feeling great and making others feel great. Nardi #feelingbetter

Nardi è il risultato di una storia imprenditoriale che ha come cardini la cultura del progetto open air, l'attitudine all'innovazione e il design. L'azienda promuove l'incontro tra un disegno unico e la tecnologia più all'avanguardia, la qualità unita alla funzionalità e il pensiero ecologico che si realizza nella totale riciclabilità dei prodotti, nel riutilizzo degli scarti di produzione e nella progettazione di packaging eco-compatibili. Nardi distribuisce i suoi prodotti in tutto il mondo puntando a rendere unici ed accoglienti gli spazi esterni.

Nardi is the result of an entrepreneurial story, with its roots in the culture of open air projects and a talent for innovation and design. The company brings together unique designs and the most avant-garde technology, combining quality with functionality and an environmentally-friendly approach, with completely recyclable products, recycling of manufacturing waste and the design of eco-friendly packaging. Nardi distributes its products throughout the world, with the aim of making outdoor spaces unique and welcoming.

visione
vision

Nardi realizza arredi per l'outdoor adatti ad ambienti home e collettivi, studiati per il benessere e il relax delle persone.

Il polipropilene fiber-glass di alta qualità è protagonista di tutte le collezioni che nascono da un'approfondita ricerca di design, colore e abbinamento di materiali. Ogni prodotto è realizzato in una filiera completamente Made in Italy e sottoposto a severi controlli di qualità. Ogni singola fase di processo è seguita da personale competente e valorizzato dall'azienda che pone al centro i rapporti con le persone.

Nardi produces outdoor furniture that is suitable for homes and communal areas, designed for people to relax and unwind. High quality, polypropylene fiberglass plays the leading role in every collection, all of which are created following extensive research into design, colour and the combination of materials. The company's production chain is entirely 'Made in Italy', with each product undergoing strict quality control checks. Every single phase of the production process is followed by expert members of staff and valued by the company, which considers solid relationships with its people as being a fundamental key to success.

produzione
production

komodo	11
rio - trill	33
net table - net bench - net relax	41
rio - net relax - net - bit	55
aria	75
alloro - aria - palma	83
loto - ninfea	95
atlantico - pop	107
cuscini	117
schede tecniche/technical details	123

index



komodo























**rio
trill**









**net table
net bench
net relax**















rio
net relax
net
bit





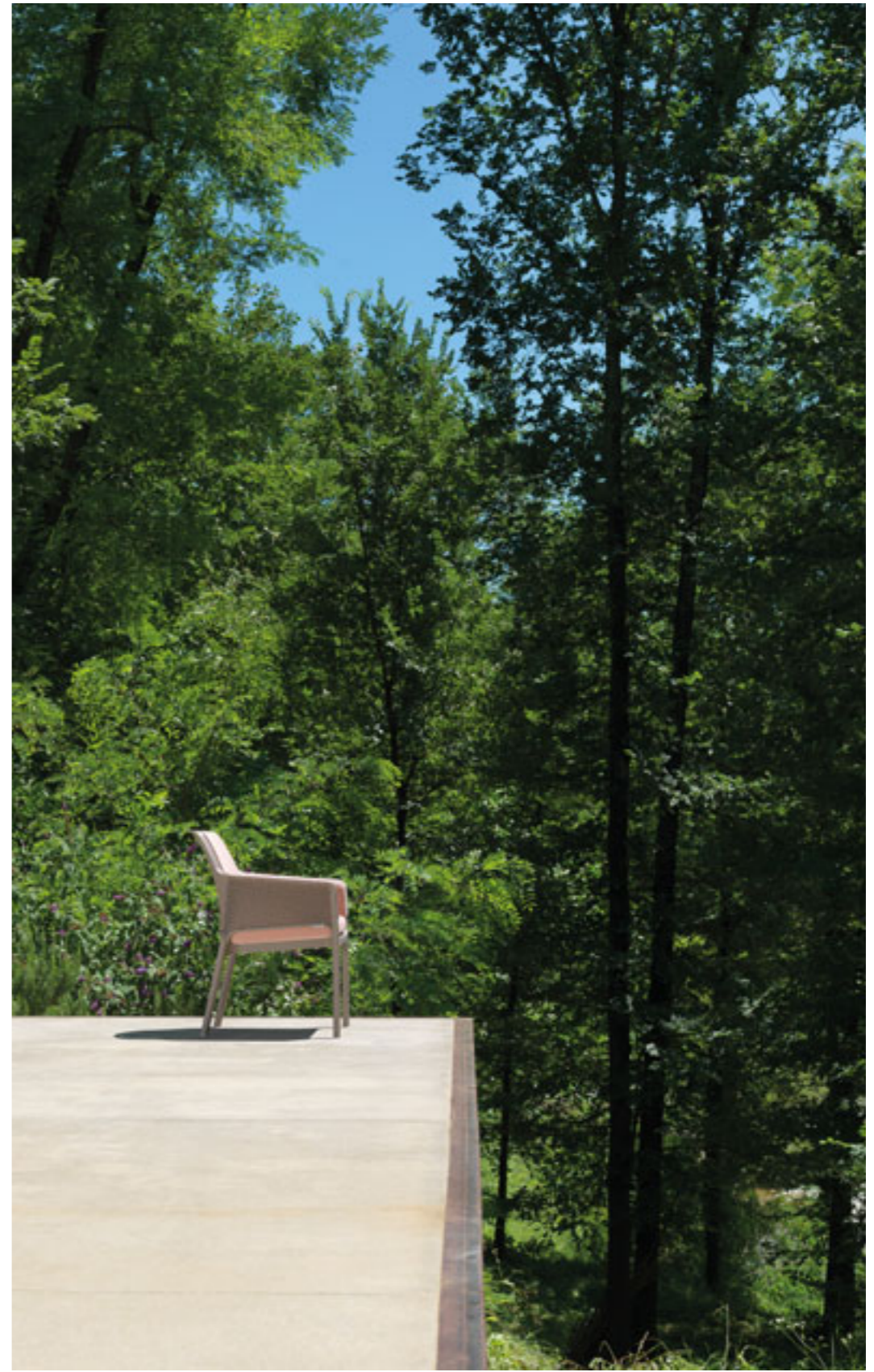

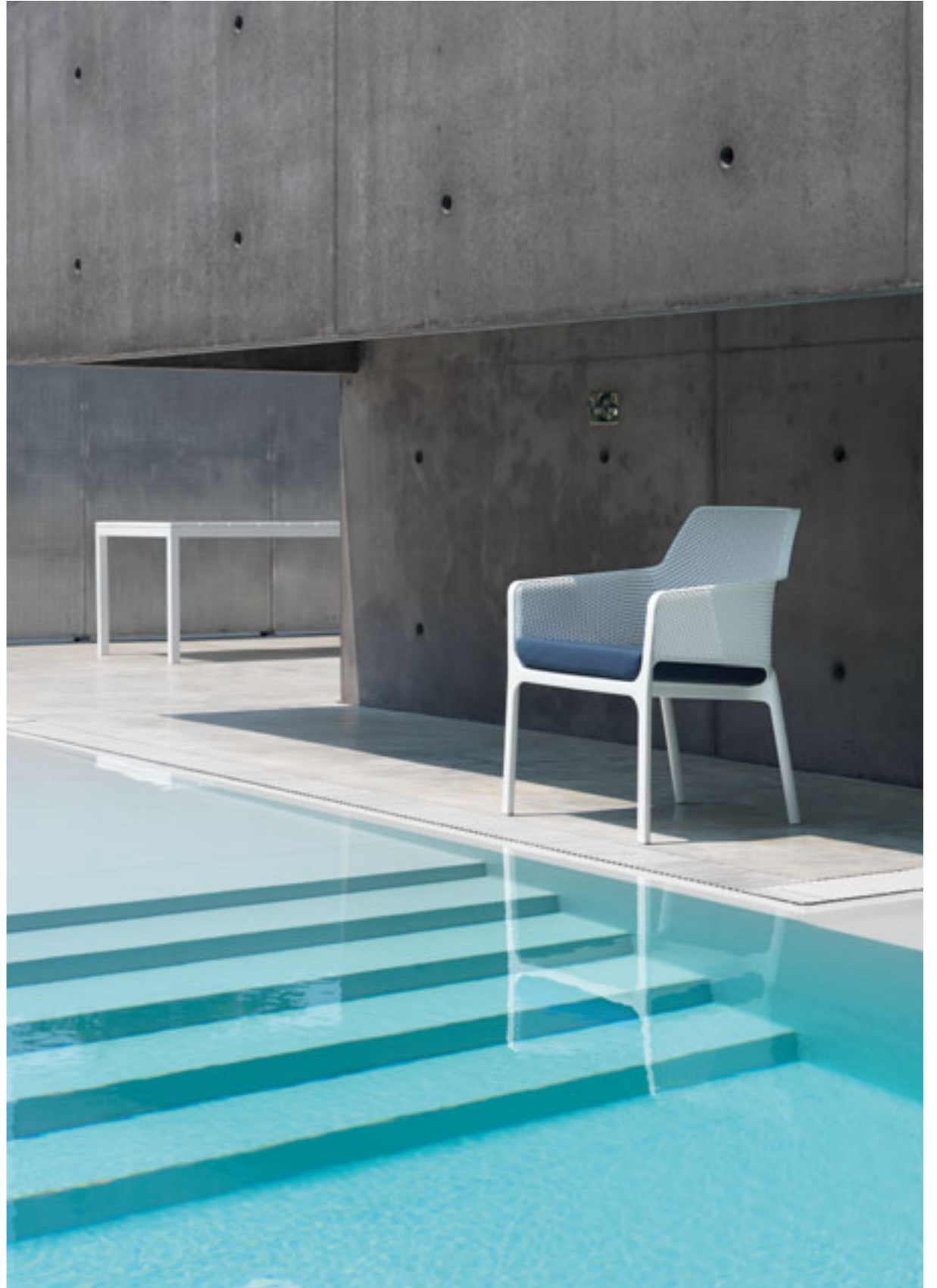
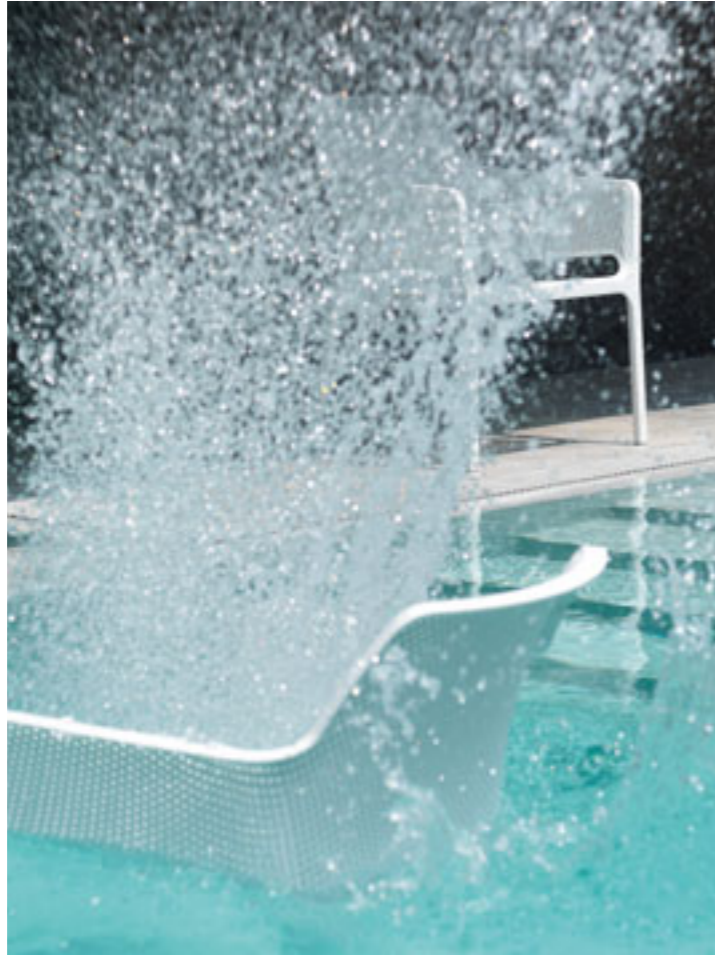

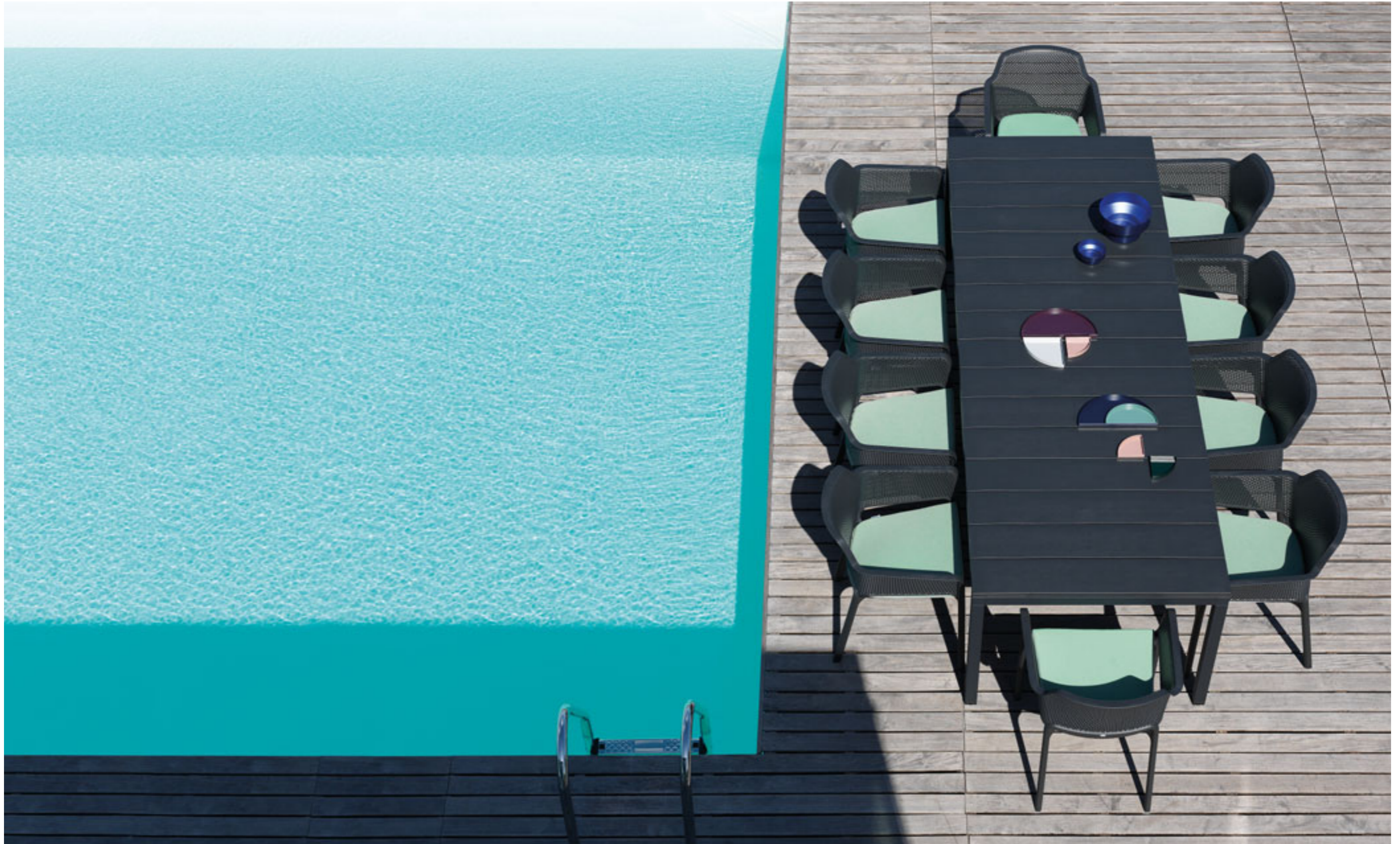

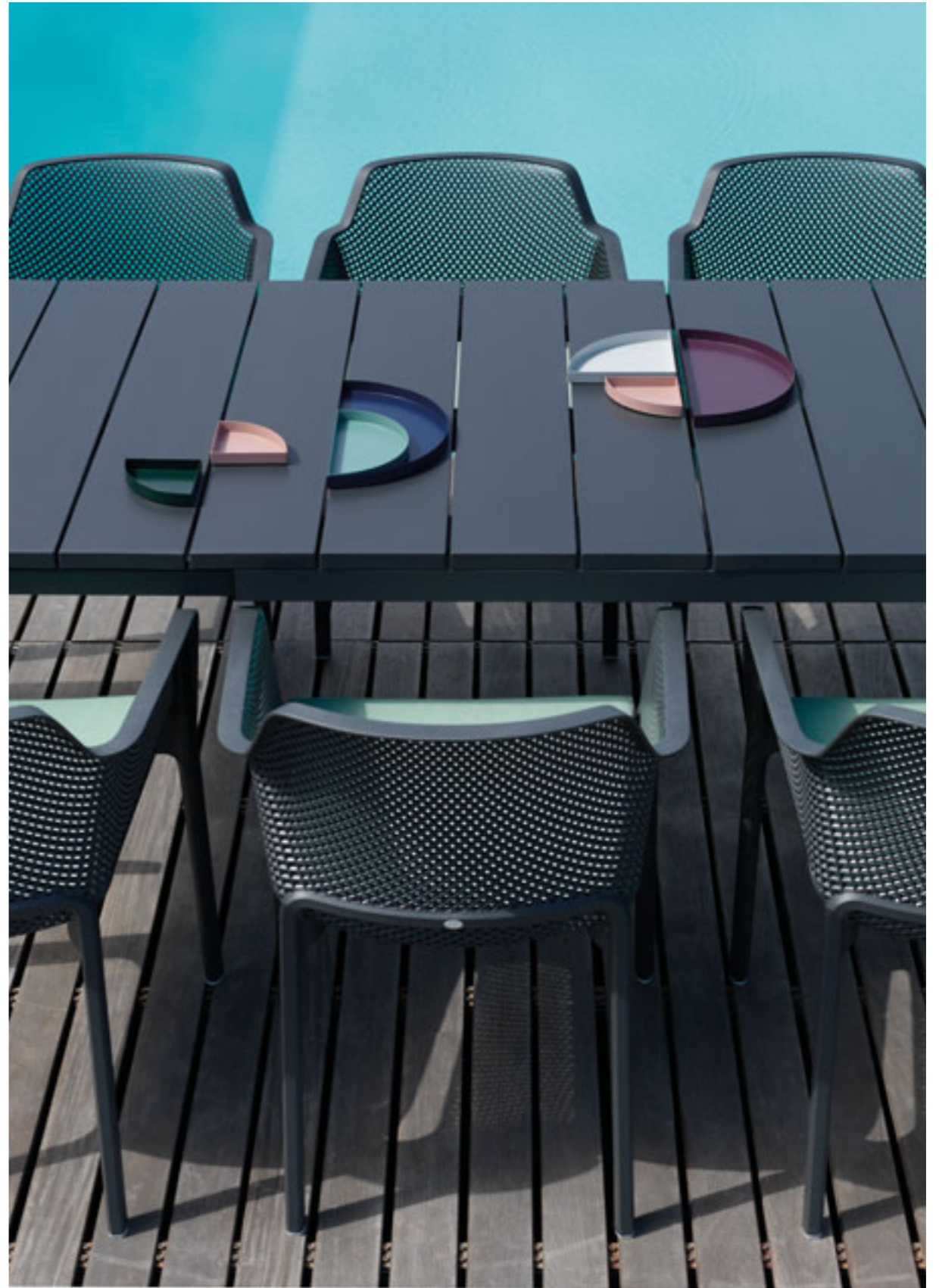









aria









**alloro
aria
palma**









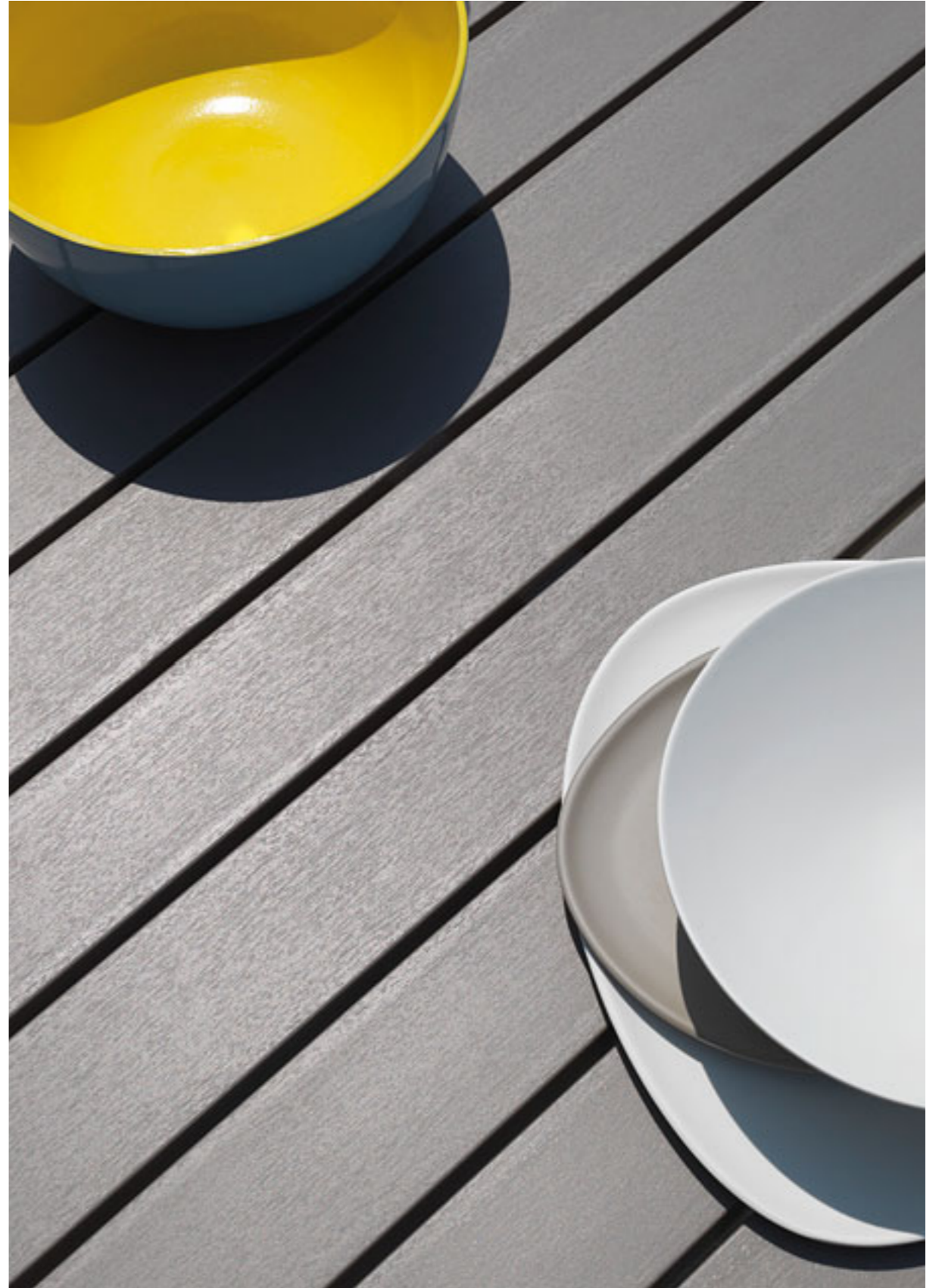



**loto
ninfea**









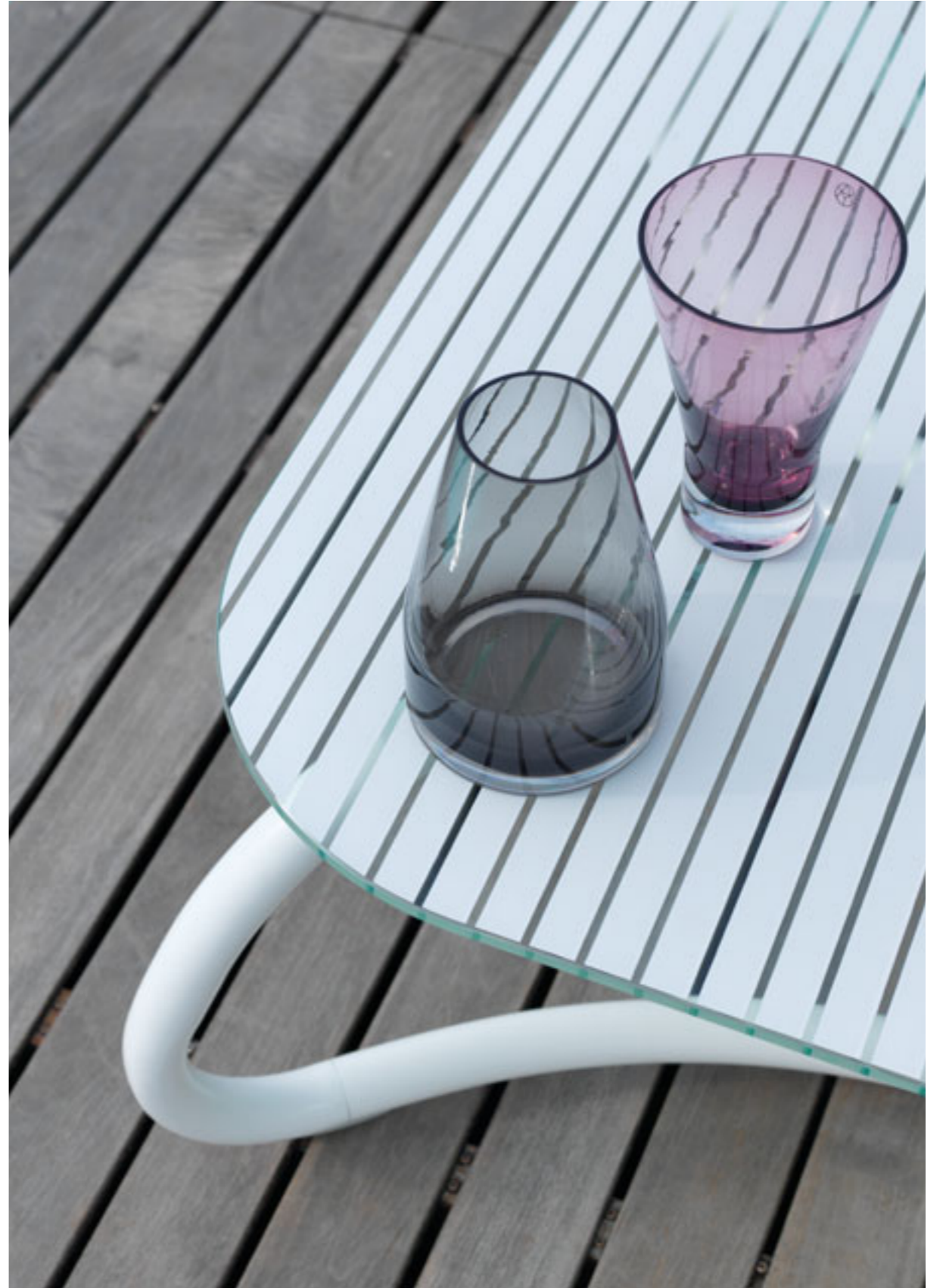
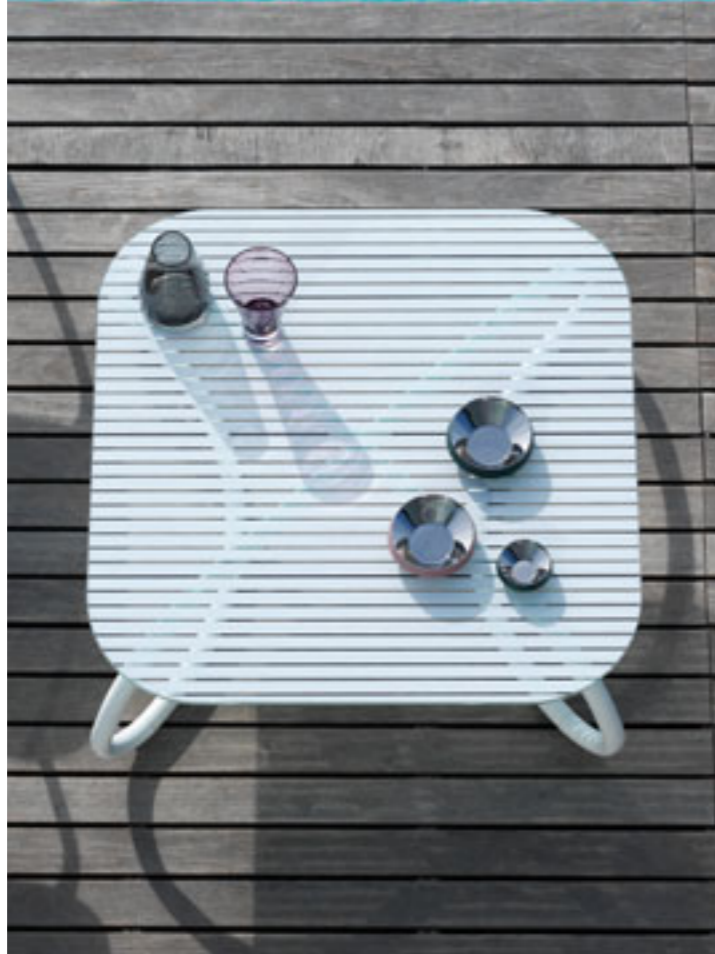



**atlantico
pop**

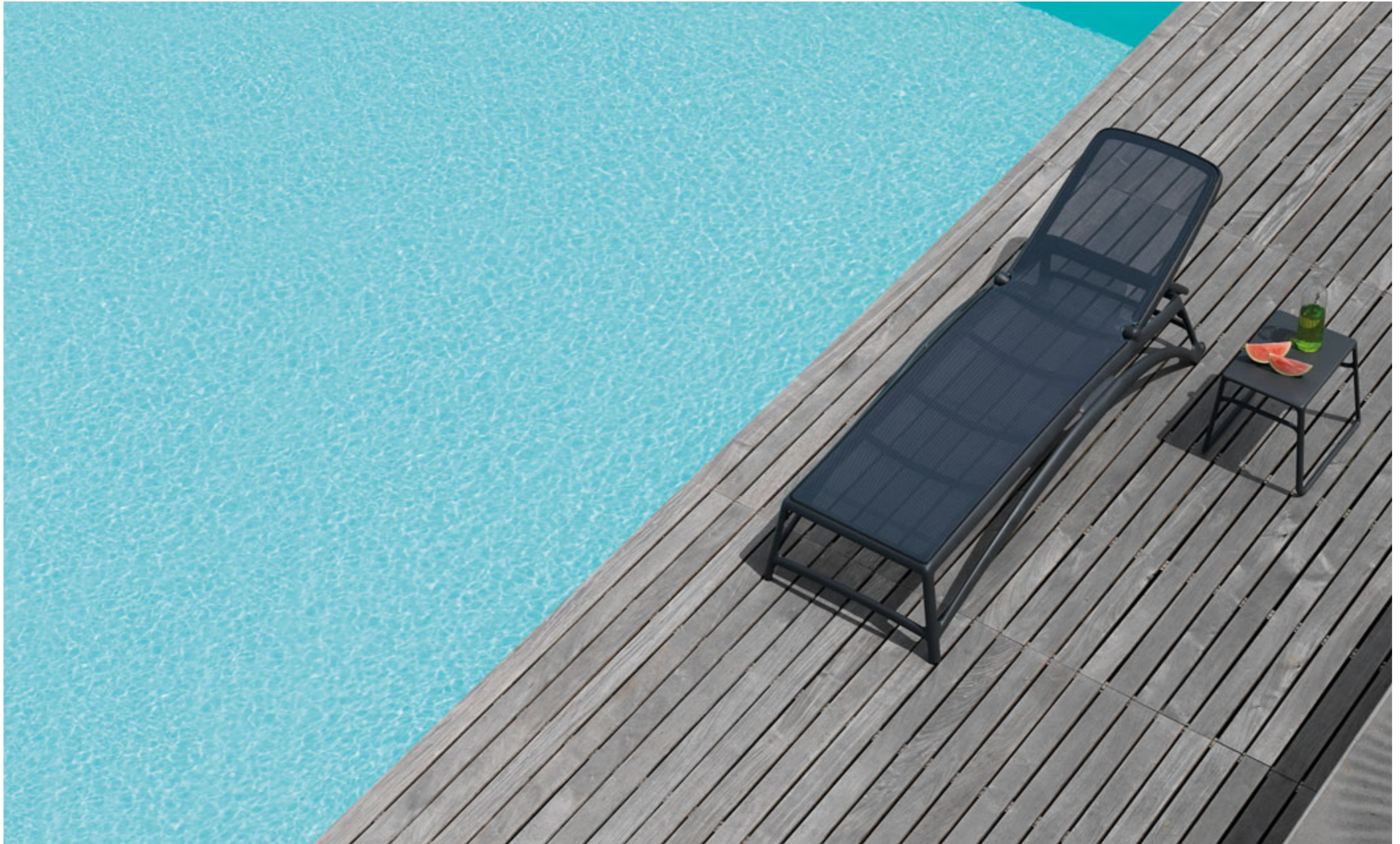









cuscini





schede tecniche
technical details

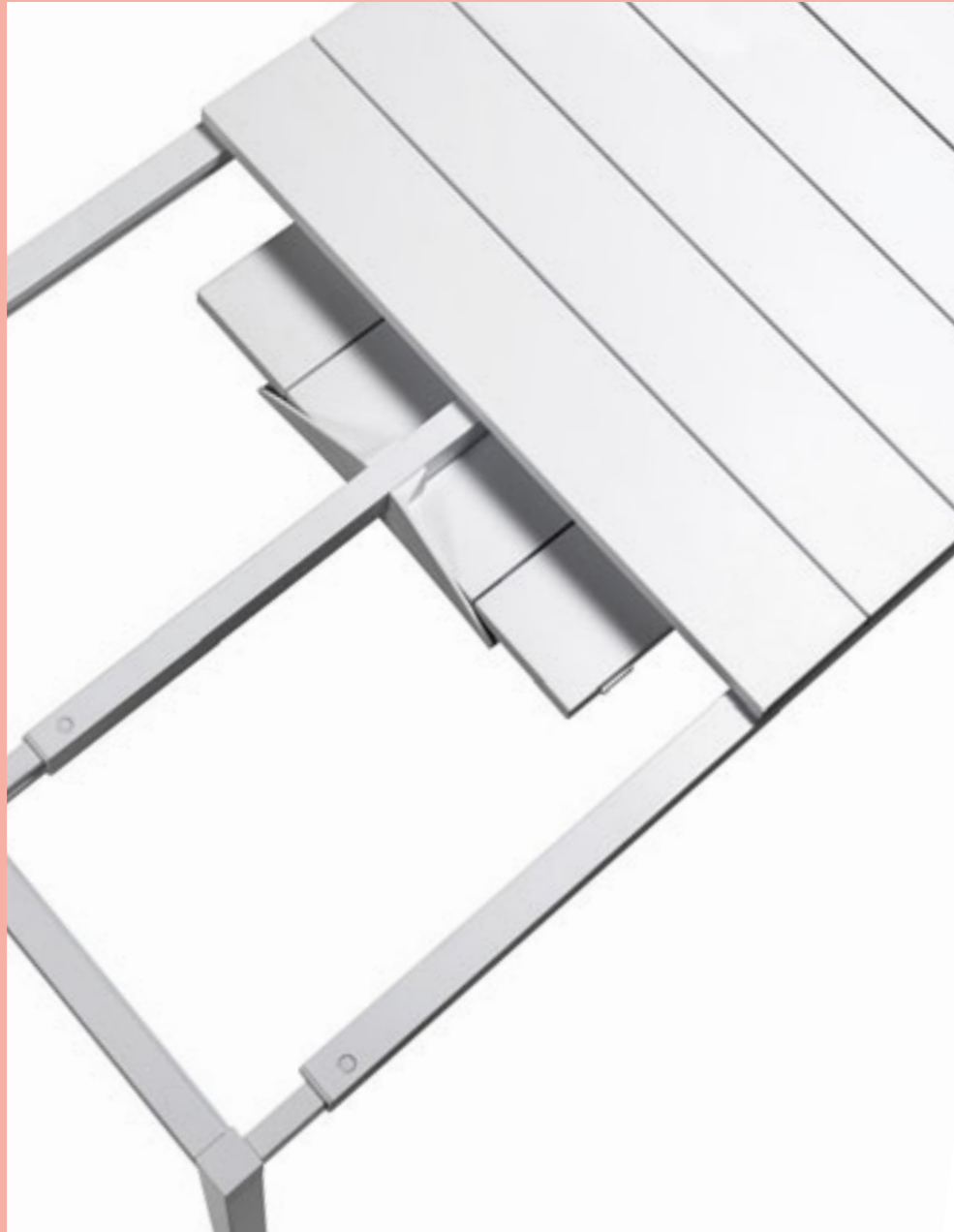

RIO

rio 140 extensible
6/8 🧑 140/210x85x76 cm

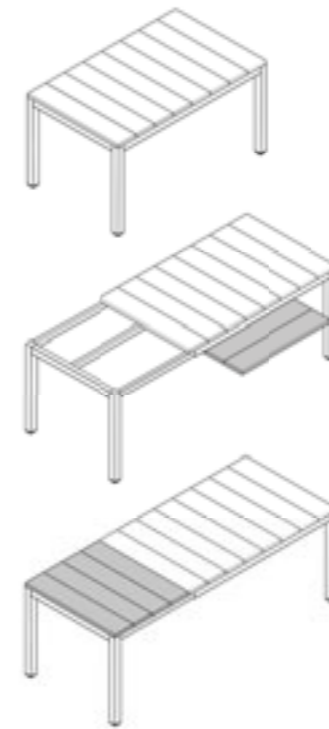

rio 210 extensible
8/10 🧑 210/280x100x76 cm



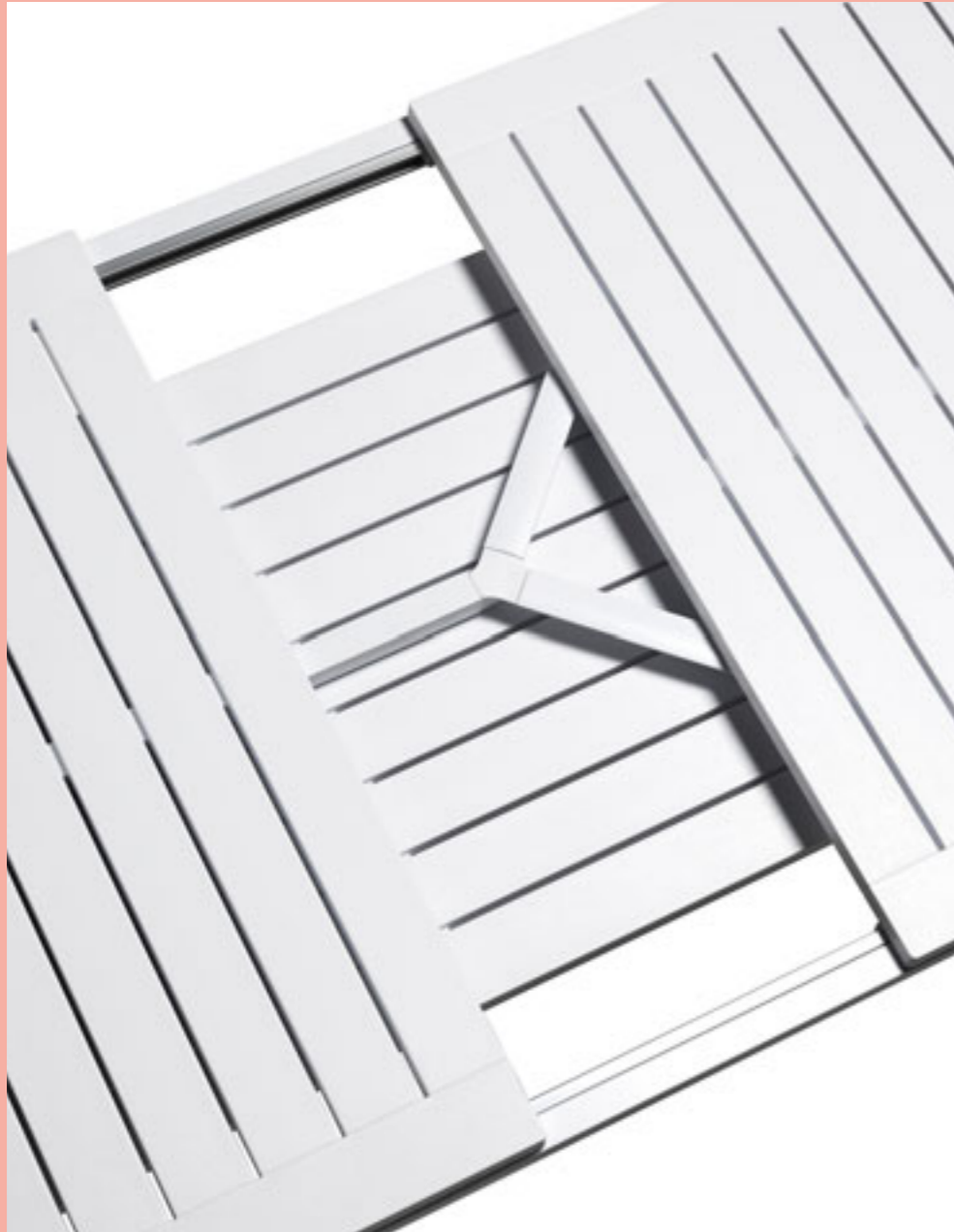

ALLORO

alloro 140 extensibile
6/8 🧑 140/210x100x73 cm

alloro 210 extensibile
8/10 🧑 210/280x100x73 cm

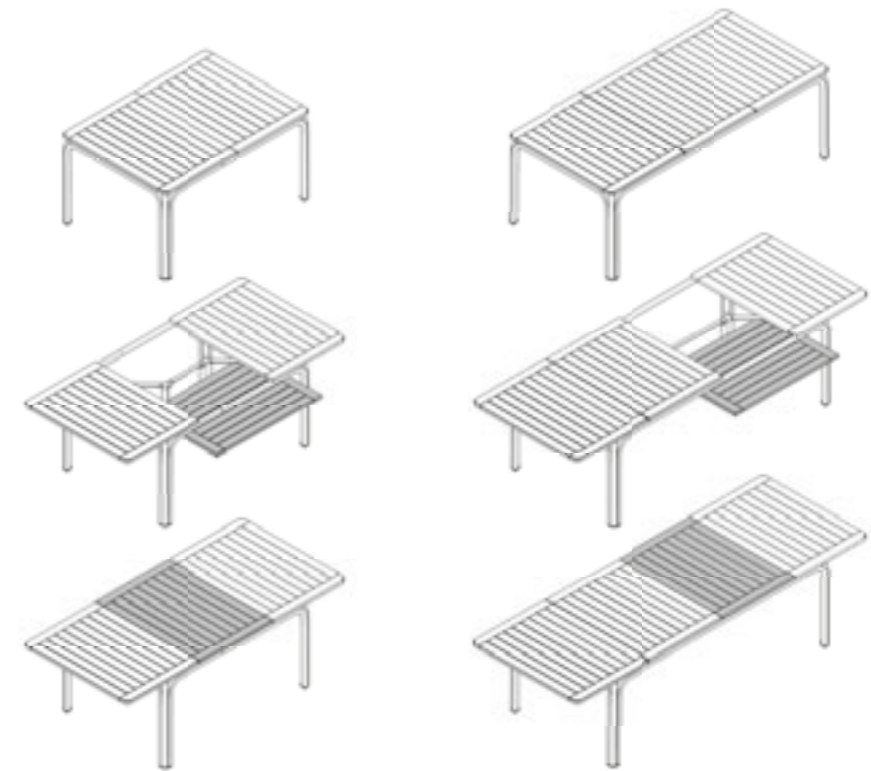



KOMODO

Divano modulare | Modular sofa

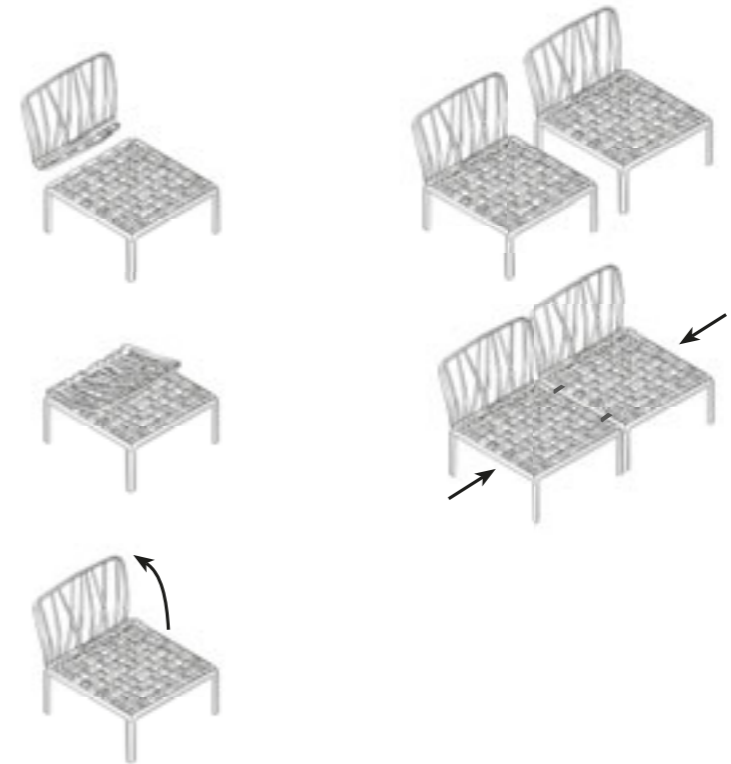



KOMODO 5 **new**

polipropilene fiberglass
tessuto

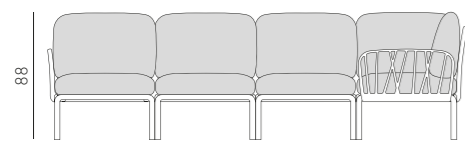
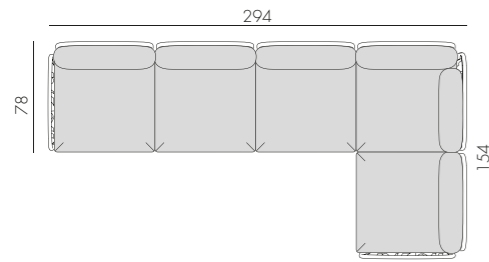

41,1 kg
n. pz. 1

BIANCO grigio 40370.00.163	BIANCO rosa quarzo 40370.00.066	BIANCO canvas Sunbrella® 40370.00.141	BIANCO adriatic Sunbrella® 40370.00.142
ANTRACITE grigio 40370.02.163	ANTRACITE rosa quarzo 40370.02.066	ANTRACITE canvas Sunbrella® 40370.02.141	ANTRACITE adriatic Sunbrella® 40370.02.142
TORTORA grigio 40370.10.163	TORTORA rosa quarzo 40370.10.066	TORTORA canvas Sunbrella® 40370.10.141	TORTORA adriatic Sunbrella® 40370.10.142

SOLUTIONS

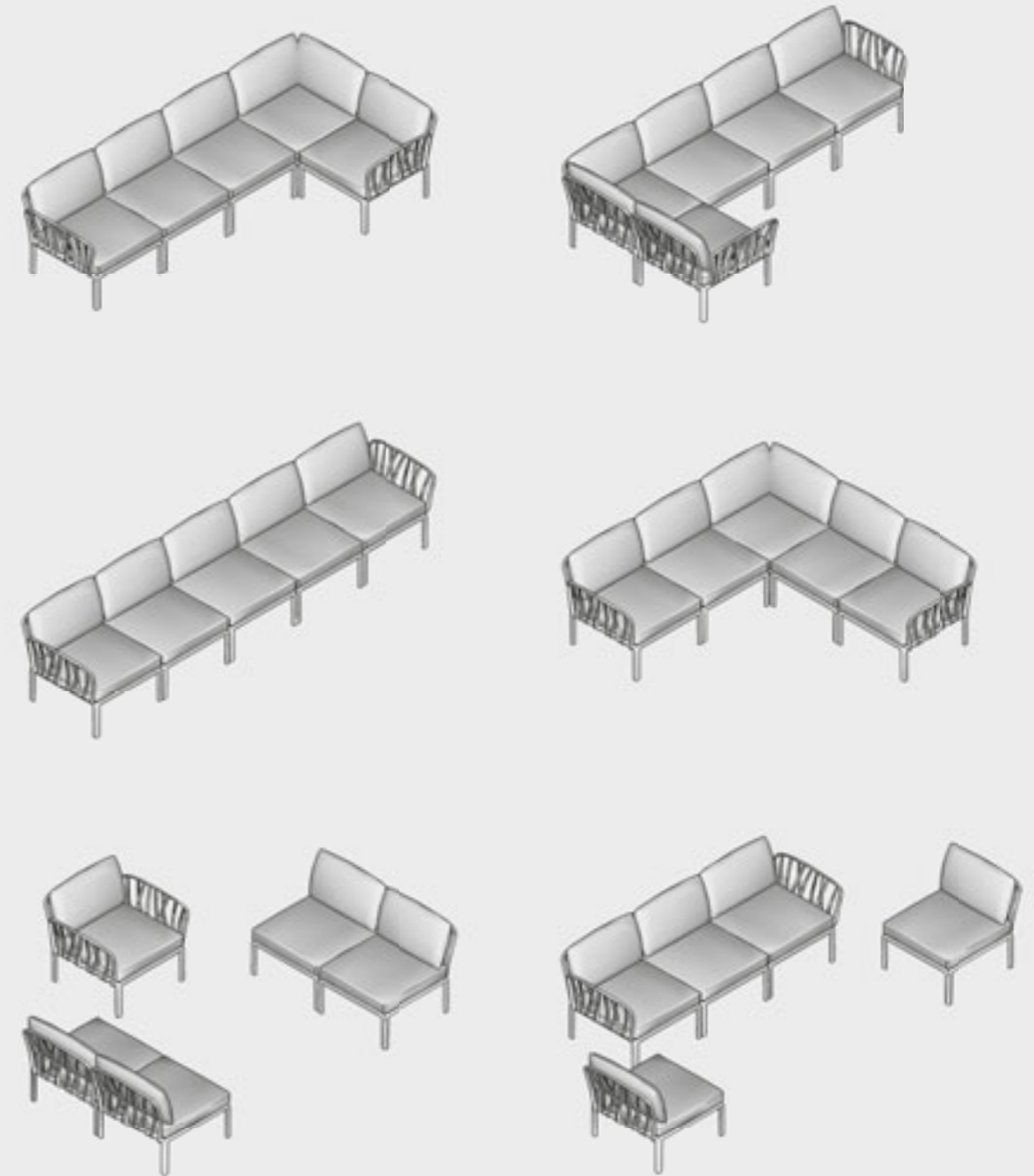

KOMODO è un divano modulare configurabile a piacere. Le sedute possono essere fissate tra loro e gli schienali e i braccioli sono agganciabili su tutti i lati. Oltre alla versione standard KOMODO 5, è possibile configurare e ordinare la tua versione di KOMODO elencando tutti i singoli componenti che lo formano.

KOMODO is a modular sofa which can be configured to suit your particular needs. The seats can be secured to one another and the seat backs and armrests can be attached on all sides. In addition to the standard KOMODO 5 version, you can configure and order your own version of KOMODO simply by listing all the individual components you require.

KOMODO BRACCIOLO **new**

polipropilene fiberglass

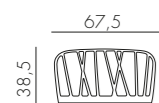

1,7 kg
n. pz. 2



BIANCO
40375.00.000

ANTRACITE
40375.02.000

TORTORA
40375.10.000

KOMODO SCHIENALE **new**

polipropilene fiberglass

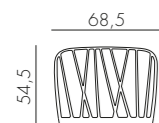

2 kg
n. pz. 4



BIANCO
40376.00.000

ANTRACITE
40376.02.000

TORTORA
40376.10.000

KOMODO SEDUTA **new**

polipropilene fiberglass

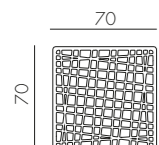

5,1 kg
n. pz. 4



BIANCO
40377.00.000

ANTRACITE
40377.02.000

TORTORA
40377.10.000

CUSCINO SCHIENALE KOMODO **new**

tessuto

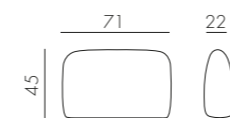

1,3 kg
n. pz. 1



grigio
36370.52.163

rosa quarzo
36370.52.066

canvas Sunbrella®
36370.52.141

adriatic Sunbrella®
36370.52.142

CUSCINO SCHIENALE ANGOLO KOMODO **new**

tessuto



1,1 kg
n. pz. 1

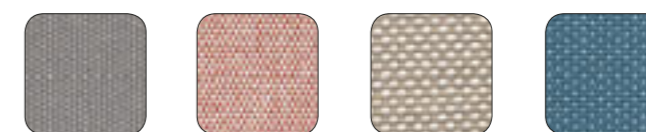

grigio
36370.54.163

rosa quarzo
36370.54.066

canvas Sunbrella®
36370.54.141

adriatic Sunbrella®
36370.54.142

CUSCINO SEDUTA KOMODO **new**

tessuto

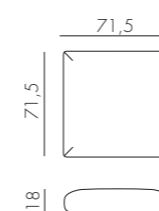

2,4 kg
n. pz. 1

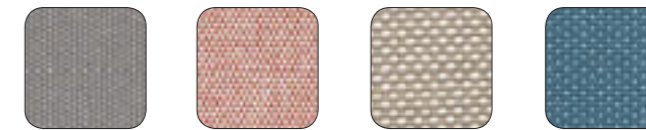

grigio
36370.60.163

rosa quarzo
36370.60.066

canvas Sunbrella®
36370.60.141

adriatic Sunbrella®
36370.60.142

KOMODO TAVOLINO **new**

polipropilene fiberglass

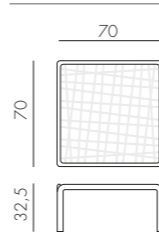

6,7 kg
n. pz. 1



BIANCO
40378.00.000

ANTRACITE
40378.02.000

TORTORA
40378.10.000



KOMODO WALL **new**

polipropilene fiberglass

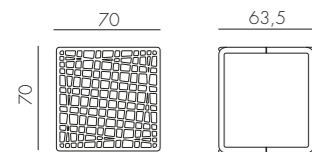

BIANCO	ANTRACITE	TORTORA
40379.00.000	40379.02.000	40379.10.000

11,5 kg
n. pz. 1

TRILL ARMCHAIR **new**

polipropilene fiberglass

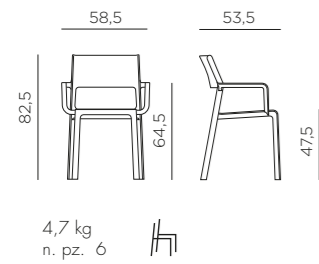

BIANCO 40250.00.000 ANTRACITE 40250.02.000 TORTORA 40250.10.000 AGAVE 40250.16.000 OTTANIO 40250.49.000 TABACCO 40250.53.000 SENAPE 40250.56.000

4,7 kg
n. pz. 6



NET BENCH

polipropilene fiberglass

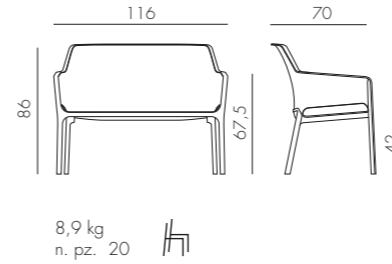

BIANCO 40338.00.000 ANTRACITE 40338.02.000 SALICE 40338.04.000 TORTORA 40338.10.000 SENAPE 40338.56.000 CORALLO 40338.75.000

8,9 kg
n. pz. 20



TRILL BISTROT **new**

polipropilene fiberglass

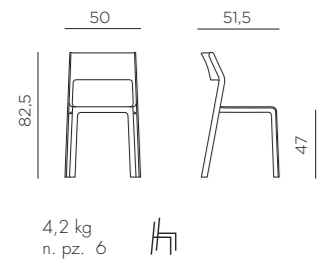

BIANCO 40253.00.000 ANTRACITE 40253.02.000 TORTORA 40253.10.000 AGAVE 40253.16.000 OTTANIO 40253.49.000 TABACCO 40253.53.000 SENAPE 40253.56.000

4,2 kg
n. pz. 6



NET RELAX

polipropilene fiberglass

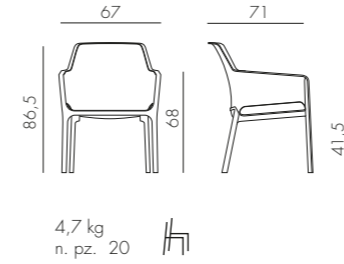

BIANCO 40327.00.000 ANTRACITE 40327.02.000 SALICE 40327.04.000 TORTORA 40327.10.000 SENAPE 40327.56.000 CORALLO 40327.75.000

4,7 kg
n. pz. 20



TRILL STOOL **new**

polipropilene fiberglass

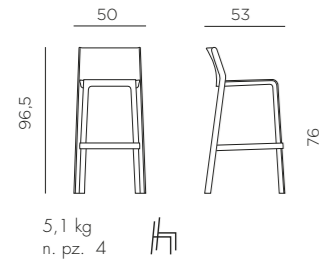

BIANCO 40350.00.000 ANTRACITE 40350.02.000 TORTORA 40350.10.000 AGAVE 40350.16.000 OTTANIO 40350.49.000 TABACCO 40350.53.000 SENAPE 40350.56.000

5,1 kg
n. pz. 4



NET

polipropilene fiberglass

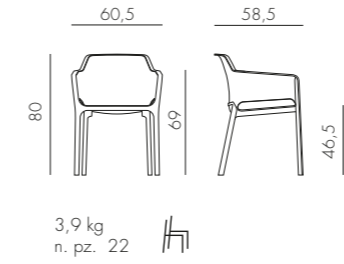

BIANCO 40326.00.000 ANTRACITE 40326.02.000 SALICE 40326.04.000 TORTORA 40326.10.000 SENAPE 40326.56.000 CORALLO 40326.75.000

3,9 kg
n. pz. 22



TRILL STOOL MINI **new**

polipropilene fiberglass

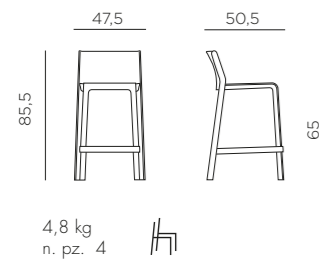

BIANCO 40353.00.000 ANTRACITE 40353.02.000 TORTORA 40353.10.000 AGAVE 40353.16.000 OTTANIO 40353.49.000 TABACCO 40353.53.000 SENAPE 40353.56.000

4,8 kg
n. pz. 4



BIT

polipropilene fiberglass

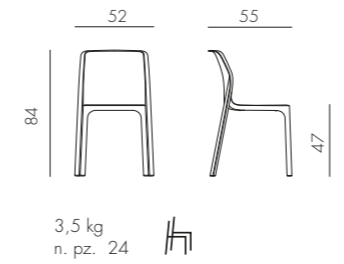

BIANCO 40328.00.000 ANTRACITE 40328.02.000 SALICE 40328.04.000 TORTORA 40328.10.000 SENAPE 40328.56.000 CORALLO 40328.75.000

3,5 kg
n. pz. 24



CUSCINO NET BENCH

tessuto

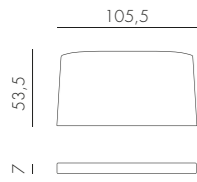

1,5 kg
n. pz. 4

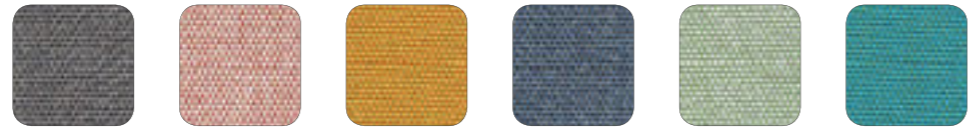

grey stone 36338.00.064
rosa quarzo 36338.00.066
senape 36338.00.069
denim 36338.00.070
the verde 36338.00.071
sardinia 36338.00.072



bianco 36338.00.155
grigio 36338.00.163
grigio sunbrella® 36338.00.136

CUSCINO NET RELAX

tessuto

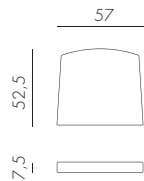

0,8 kg
n. pz. 4

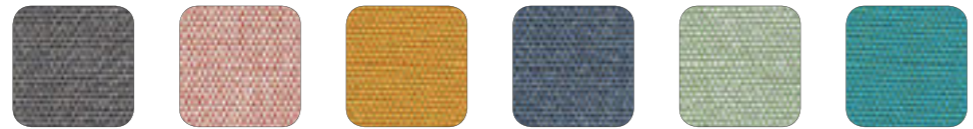

grey stone 36327.00.064
rosa quarzo 36327.00.066
senape 36327.00.069
denim 36327.00.070
the verde 36327.00.071
sardinia 36327.00.072



bianco 36327.00.155
grigio 36327.00.163
grigio sunbrella® 36327.00.136

CUSCINO SHELL (NET RELAX)

tessuto



2,2 kg
n. pz. 2



rosa quarzo 36327.01.066
denim 36327.01.070
grigio 36327.01.163

CUSCINO NET

tessuto

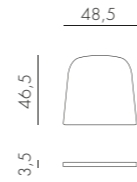

0,3 kg
n. pz. 4

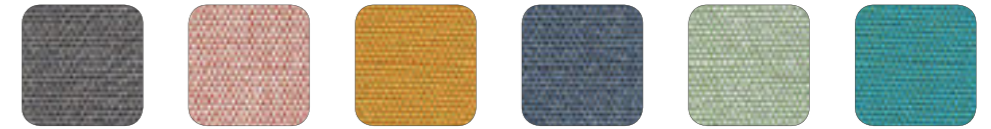

grey stone 36326.00.064
rosa quarzo 36326.00.066
senape 36326.00.069
denim 36326.00.070
the verde 36326.00.071
sardinia 36326.00.072



bianco 36326.00.155
grigio 36326.00.163
grigio Sunbrella® 36326.00.136

CUSCINO PASSEPARTOUT

tessuto

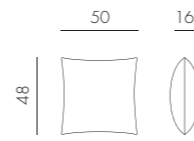

0,7 kg
n. pz. 4

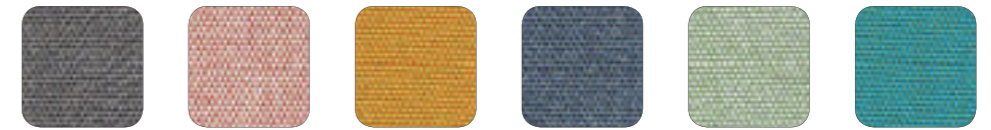

grey stone 36000.01.064
rosa quarzo 36000.01.066
senape 36000.01.069
denim 36000.01.070
the verde 36000.01.071
sardinia 36000.01.072

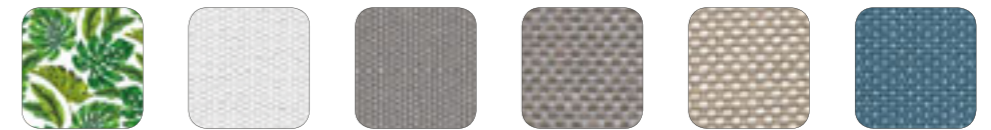

tropical 36000.01.081
bianco 36000.01.155
grigio 36000.01.163
grigio Sunbrella® 36000.01.136
canvas Sunbrella® 36000.01.141
adriatic Sunbrella® 36000.01.142

PALMA

polipropilene

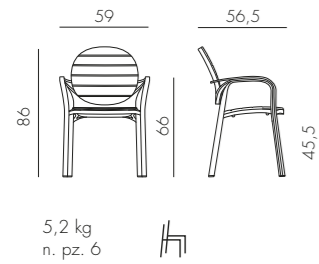

BIANCO 40237.00.000
 BIANCO TORTORA 40237.00.010
 ANTRACITE 40237.02.002
 CAFFÈ 40237.05.005
 TORTORA 40237.10.010

ERICA

polipropilene

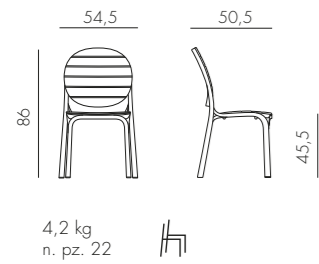

BIANCO 40236.00.000
 BIANCO TORTORA 40236.00.010
 ANTRACITE 40236.02.002
 CAFFÈ 40236.05.005
 TORTORA 40236.10.010

NINFEA DINNER

polipropilene
alluminio

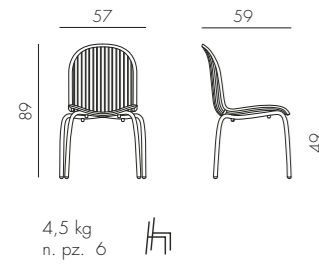

ANTRACITE vernic. antracite 62052.02.000
 BIANCO vernic. bianco 62053.00.000

NINFEA RELAX

polipropilene
alluminio

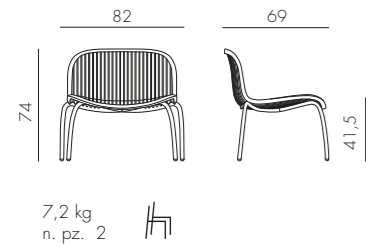

ANTRACITE vernic. antracite 62252.02.000
 BIANCO vernic. bianco 62253.00.000

ARIA (POLTRONA ARIA + CUSCINO SEDUTA + CUSCINO ARREDO)

polipropilene
tessuto

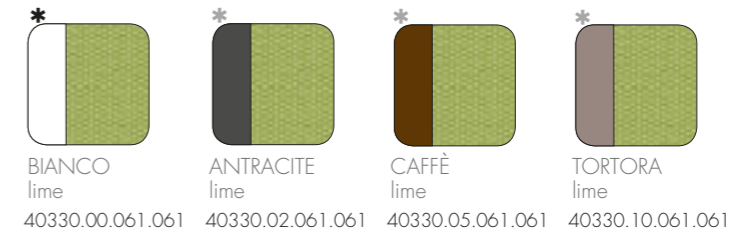
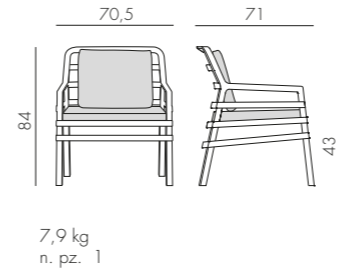

BIANCO lime 40330.00.061.061
 ANTRACITE lime 40330.02.061.061
 CAFFÈ lime 40330.05.061.061
 TORTORA lime 40330.10.061.061

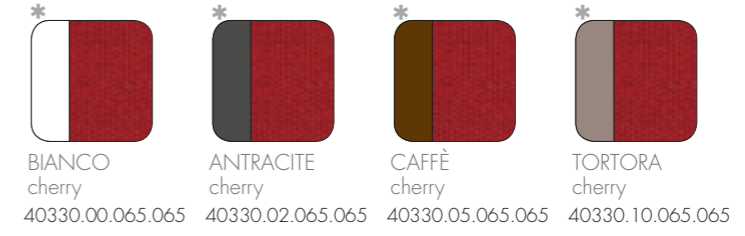

BIANCO cherry 40330.00.065.065
 ANTRACITE cherry 40330.02.065.065
 CAFFÈ cherry 40330.05.065.065
 TORTORA cherry 40330.10.065.065

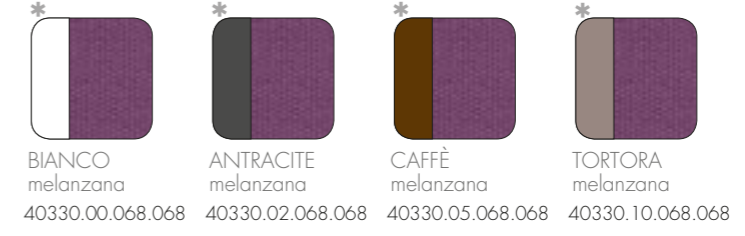

BIANCO melanzana 40330.00.068.068
 ANTRACITE melanzana 40330.02.068.068
 CAFFÈ melanzana 40330.05.068.068
 TORTORA melanzana 40330.10.068.068

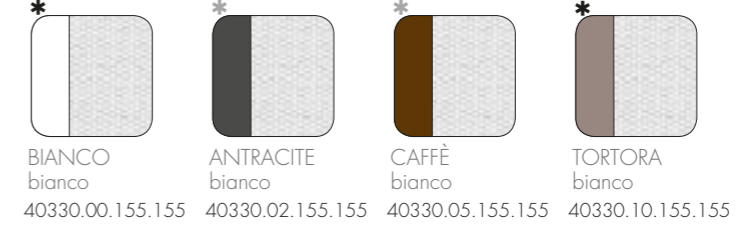

BIANCO bianco 40330.00.155.155
 ANTRACITE bianco 40330.02.155.155
 CAFFÈ bianco 40330.05.155.155
 TORTORA bianco 40330.10.155.155

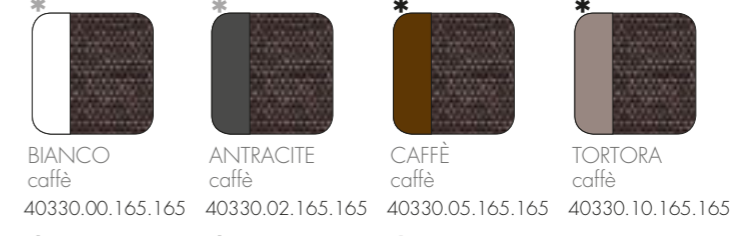

BIANCO caffè 40330.00.165.165
 ANTRACITE caffè 40330.02.165.165
 CAFFÈ caffè 40330.05.165.165
 TORTORA caffè 40330.10.165.165



BIANCO grigio 40330.00.163.163
 ANTRACITE grigio 40330.02.163.163
 CAFFÈ grigio 40330.05.163.163
 TORTORA grigio 40330.10.163.163



BIANCO grigio Sunbrella® 40330.00.136.136
 ANTRACITE grigio Sunbrella® 40330.02.136.136
 CAFFÈ grigio Sunbrella® 40330.05.136.136
 TORTORA grigio Sunbrella® 40330.10.136.136

* Disponibile a magazzino
 Available ex-stock
 Disponible sur stock
 Ab Lager verfügbar
 Disponible en almacén habitualmente
 Disponivel em estoque
 Stokta mevcut
 Наличие на складе

* Disponibile su ordine
 Available to order
 Disponible sur commande
 Mit Auftrag verfügbar
 Disponible sólo sobre pedido
 Disponivel sob encomenda
 Sipariş göre hazırlanacaktır
 Под заказ

ARIA FIT (POLTRONA ARIA + CUSCINO SEDUTA + CUSCINO FIT)

polipropilene
tessuto

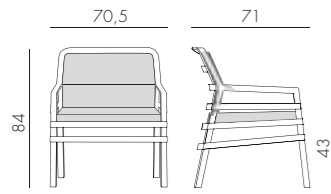

7,9 kg
n. pz. 1

BIANCO bianco 40330.00.155.FIT	ANTRACITE bianco 40330.02.155.FIT	CAFFÈ bianco 40330.05.155.FIT	TORTORA bianco 40330.10.155.FIT
BIANCO caffè 40330.00.165.FIT	ANTRACITE caffè 40330.02.165.FIT	CAFFÈ caffè 40330.05.165.FIT	TORTORA caffè 40330.10.165.FIT
BIANCO grigio 40330.00.163.FIT	ANTRACITE grigio 40330.02.163.FIT	CAFFÈ grigio 40330.05.163.FIT	TORTORA grigio 40330.10.163.FIT
BIANCO grigio Sunbrella® 40330.00.136.FIT	ANTRACITE grigio Sunbrella® 40330.02.136.FIT	CAFFÈ grigio Sunbrella® 40330.05.136.FIT	TORTORA grigio Sunbrella® 40330.10.136.FIT

* Disponibile su ordine
Available to order
Disponibile sur commande
Mit Auftrag verfügbar
Disponibile sólo sobre pedido
Disponível sob encomenda
Sipariş göre hazırlanacaktır
Под заказ

CUSCINO SEDUTA ARIA

tessuto

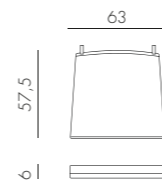

0,8 kg
n. pz. 4

lime 36330.00.061	cherry 36330.00.065	melanzana 36330.00.068	bianco 36330.00.155	caffè 36330.00.165	grigio 36330.00.163
grigio Sunbrella® 36330.00.136					

CUSCINO ARREDO ARIA

tessuto

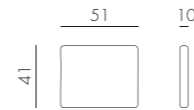

0,5 kg
n. pz. 4

lime 36330.01.061	cherry 36330.01.065	melanzana 36330.01.068	bianco 36330.01.155	caffè 36330.01.165	grigio 36330.01.163
grigio Sunbrella® 36330.01.136					

CUSCINO FIT ARIA

tessuto

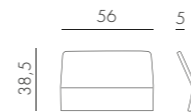

0,5 kg
n. pz. 4

bianco 36330.04.155	caffè 36330.04.165	grigio 36330.04.163	grigio Sunbrella® 36330.04.136

ATLANTICO

polipropilene fiberglass
tessuto sintetico 1 x 1

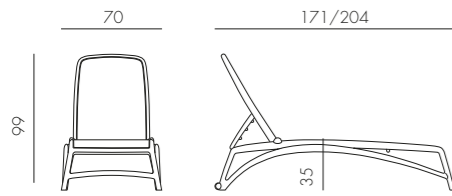

16 kg
n. pz. 20

Tessuto ricambiabile
Replaceable fabric
Tissu changeable
Auswechselbarer Stoff
Tela sustituible
Tecidos recambiáveis
Değiştirilebilen Kumaş
Съемная ткань



RICAMBIO atlantico

resina acetilica
tessuto sintetico 1 x 1

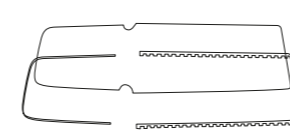

1,3 kg
n. pz. 1

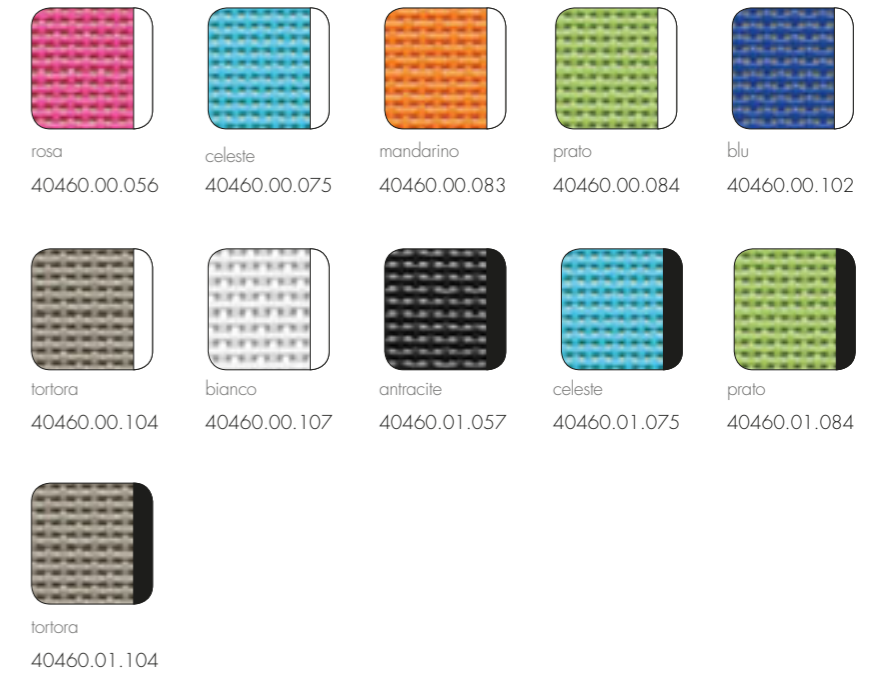

BRACCIOLO ATLANTICO

polipropilene fiberglass

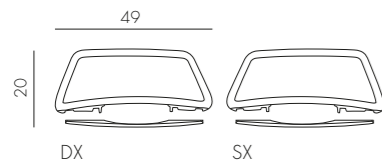

1,1 kg
n. pz. 1

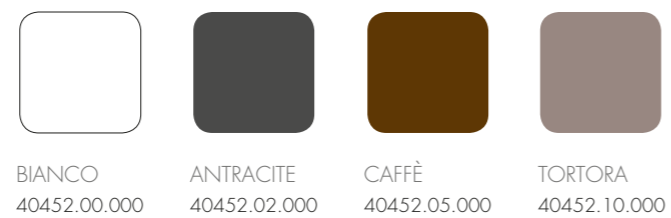

RIO 210 EXTENSIBLE 8/10

durelTOP - polipropilene
alluminio

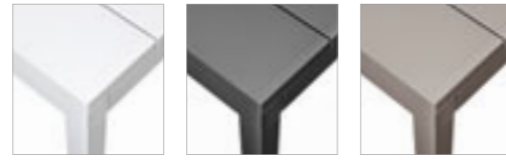
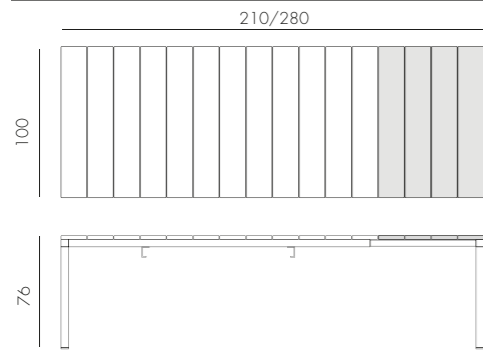

BIANCO verniciato bianco 48253.00.000	ANTRACITE* verniciato antracite 48252.02.000	TORTORA verniciato tortora 48259.10.000
---	--	---

49 kg
n. pz. 1

RIO 140 EXTENSIBLE 6/8

durelTOP - polipropilene
alluminio

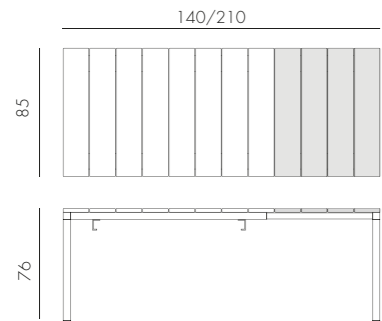

BIANCO verniciato bianco 48353.00.000	ANTRACITE* verniciato antracite 48352.02.000	TORTORA verniciato tortora 48359.10.000
---	--	---

32,6 kg
n. pz. 1

* Posizionare in zona d'ombra - Only use table tops in shaded areas - Plateaux qui doivent être utilisés uniquement dans des zones ombragées - Tischplatten nur für beschatteten Einsatzbereich - Utilizar estos tableros sólo en áreas sombreadas - Colocar em local sombreado - Gölge alana koyun - Ставить в тени

ALLORO 210 EXTENSIBLE 8/10

durelTOP - polipropilene
alluminio

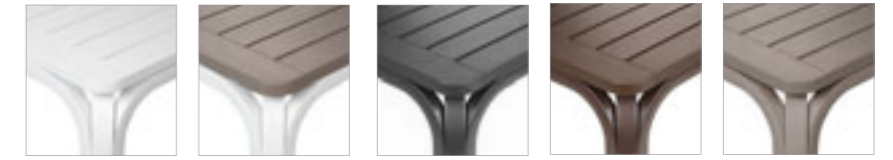
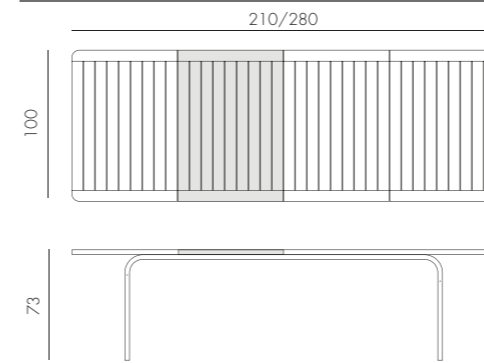

BIANCO verniciato bianco 42853.00.000	TORTORA verniciato bianco 42853.10.000	ANTRACITE* verniciato antracite 42852.02.000	CAFFÈ* verniciato caffè 42857.05.000	TORTORA verniciato tortora 42859.10.000
---	--	--	--	---

44,4 kg
n. pz. 1

ALLORO 140 EXTENSIBLE 6/8

durelTOP - polipropilene
alluminio

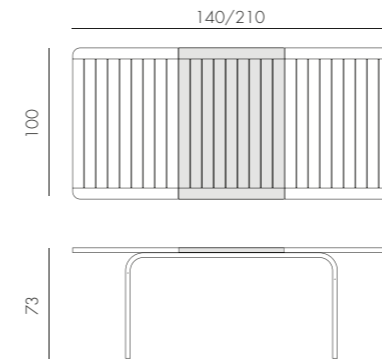

BIANCO verniciato bianco 42753.00.000	TORTORA verniciato bianco 42753.10.000	ANTRACITE* verniciato antracite 42752.02.000	CAFFÈ* verniciato caffè 42757.05.000	TORTORA verniciato tortora 42759.10.000
---	--	--	--	---

33,7 kg
n. pz. 1

* Posizionare in zona d'ombra - Only use table tops in shaded areas - Plateaux qui doivent être utilisés uniquement dans des zones ombragées - Tischplatten nur für beschatteten Einsatzbereich - Utilizar estos tableros sólo en áreas sombreadas - Colocar em local sombreado - Gölge alana koyun - Ставить в тени

LOTO DINNER 190

vetro
alluminio

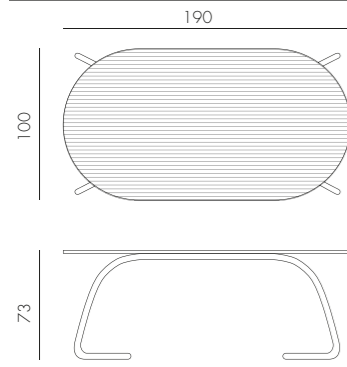

ANTRACITE
verniciato antracite
44052.02.000



BIANCO
verniciato bianco
44053.00.000

49,8 kg
n. pz. 1

LOTO DINNER Ø170

vetro
alluminio

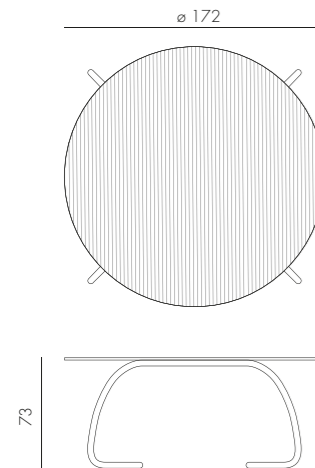

ANTRACITE
verniciato antracite
44452.02.000



BIANCO
verniciato bianco
44453.00.000

65,3 kg
n. pz. 1

LOTO DINNER Ø120

vetro
alluminio

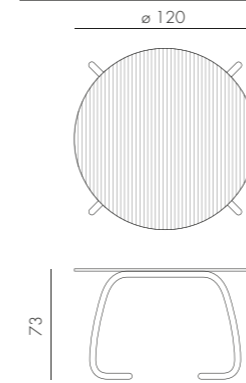

ANTRACITE
verniciato antracite
44352.02.000



BIANCO
verniciato bianco
44353.00.000

34 kg
n. pz. 1

LOTO RELAX 95

vetro
alluminio

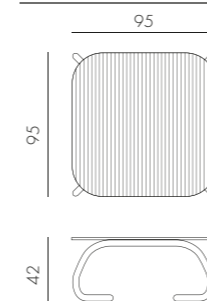

ANTRACITE
verniciato antracite
44752.02.000



BIANCO
verniciato bianco
44753.00.000

27 kg
n. pz. 1

LOTO RELAX 60

laminato
alluminio



ANTRACITE
verniciato antracite
44652.00.303



BIANCO
verniciato bianco
44653.00.301

7 kg
n. pz. 1

CUBE 80

durelTOP - polipropilene
alluminio

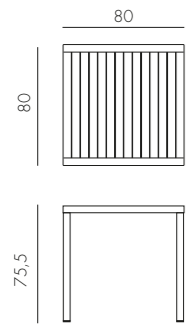

BIANCO verniciato bianco 48053.00.000	ANTRACITE verniciato antracite 48052.02.000	CAFFÈ verniciato caffè 48057.05.000	TORTORA verniciato tortora 48059.10.000
---	---	---	---

11,5 kg
n. pz. 1

CUBE 70

durelTOP - polipropilene
alluminio

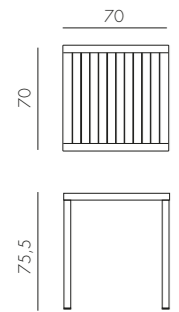

BIANCO verniciato bianco 47853.00.000	ANTRACITE verniciato antracite 47852.02.000	CAFFÈ verniciato caffè 47857.05.000	TORTORA verniciato tortora 47859.10.000
---	---	---	---

9,5 kg
n. pz. 1

NET TABLE 100

polipropilene fiberglass

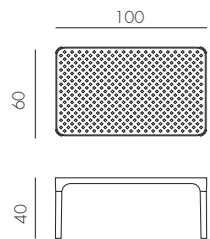

BIANCO 40064.00.000	ANTRACITE 40064.02.000	SALICE 40064.04.000	TORTORA 40064.10.000	SENAPE 40064.56.000	CORALLO 40064.75.000
------------------------	---------------------------	------------------------	-------------------------	------------------------	-------------------------

6,3 kg
n. pz. 1

ARIA TAVOLINO 100

polipropilene

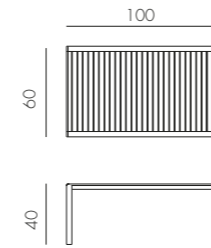

BIANCO 40052.00.000	ANTRACITE 40052.02.000	CAFFÈ 40052.05.000	TORTORA 40052.10.000
------------------------	---------------------------	-----------------------	-------------------------

8 kg
n. pz. 1

ARIA TAVOLINO 60

polipropilene

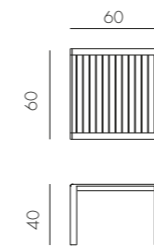

BIANCO 40051.00.000	ANTRACITE 40051.02.000	CAFFÈ 40051.05.000	TORTORA 40051.10.000
------------------------	---------------------------	-----------------------	-------------------------

5 kg
n. pz. 1

POP **new**

polipropilene fiberglass

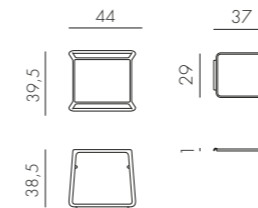

BIANCO 40048.00.000	ANTRACITE 40048.02.000	CAFFÈ 40048.05.000	TORTORA 40048.10.000
------------------------	---------------------------	-----------------------	-------------------------

2,5 kg
n. pz. 4

materiali
materials

polipropilene

Polipropilene trattato anti-UV e colorato in massa. Riciclabile al 100%.
 Polypropylene with UV additives and is uniformly colored. 100% Recyclable resin.
 Polypropylène traité anti-UV et coloré dans la masse. Résine recyclable 100%.
 UV-beständigem Polypropylen, voll durchgefärbt. 100% Recyclebarer Kunststoff.
 Polipropileno tratado anti UV y teñido en masa. Resina reciclable 100%.
 Polipropileno com tratamento anti-UV colorido na totalidade. Resina reciclável 100%.
 Işığa dayanıklı ve boyalı olarak granül çekilmiş %100 geri dönüşümlü polipropilen kompozit hammadde.
 Полипропилен с обработкой анти-УФ, окрашенное в массе. На 100% пригодно для вторичной переработки.

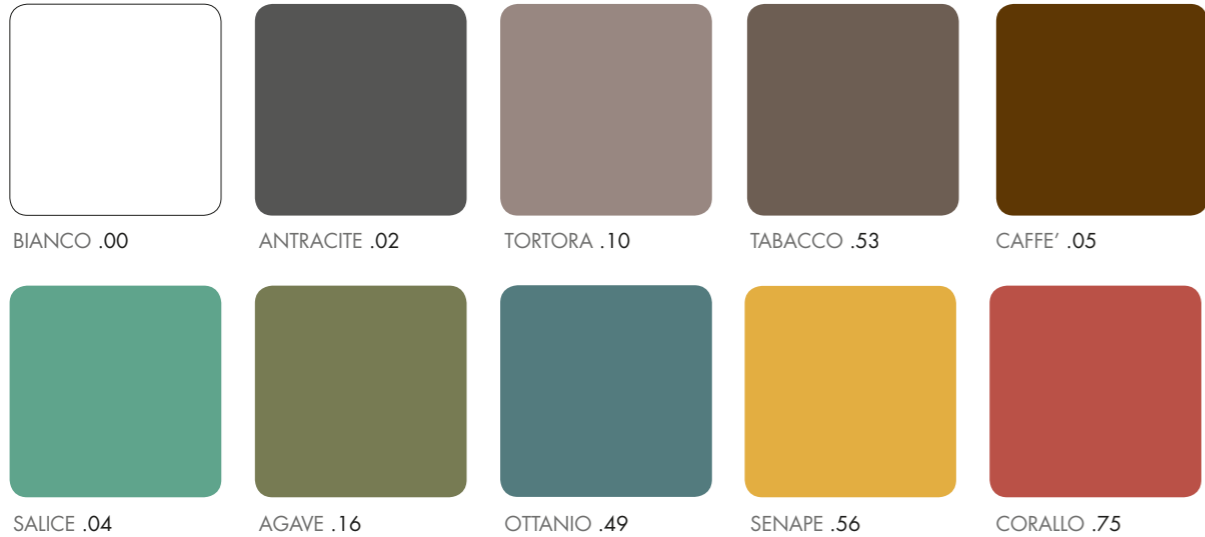

polipropilene fiberglass

Polipropilene fiberglass trattato anti-UV e colorato in massa. Resina riciclabile al 100%.
 Uniformly colored fiberglass polypropylene resins with uv additives. 100% Recyclable resin.
 Polypropylène fiberglass traité anti-uv et coloré dans la masse. Résine recyclable 100%.
 UV-beständigem fiberglass Polypropylen, voll durchgefärbt. 100% Recyclebarer Kunststoff.
 Polipropileno fiberglass tratado anti UV y teñido en masa. Resina reciclable 100%.
 Polipropileno fiberglass com tratamento anti-UV colorido na totalidade. Resina reciclável 100%.
 Işığa dayanıklı ve boyalı olarak granül çekilmiş %100 geri dönüşümlü cam elyaf katkılı polipropilen kompozit hammadde.
 Полипропилен фиброволокно с обработкой анти-УФ, окрашенное в массе. На 100% пригодно для вторичной переработки.

tessuto acrilico



Fibra acrilica 100% tinto filo. Trattamento antimacchia, antimuffa. Solidità alla luce 5/8.
 Sfoderabile/zip, lavabile a 30°.
 100% yarn dyed acrylic. Dirt repellent and anti-mould treatment. 5/8 light fastness.
 Removeable/zip, washable at 30°.
 100% fibre acrylique teintée en fils. Traitement anti-taches et anti-moisissure. Résistance à la lumière 5/8. Déhoussable/zip. Lavable à 30°.
 100% garngefärbtes Acryl-Gewebe. Gegen Flecken und Schimmel Behandlung. Lichtechtheit 5/8. Abziehbarer/zip. Waschbar bei 30°.

100% hilo teñido acrílico. Protección antimanchas, antimoho. Solidez a la luz 5/8. Desenfundable/zip. Lavable a 30°.
 100% fibra acrílica tingida com fio. Tratamento antimancha e antimoho. Resistência à luz 5/8. Removível/zip. Lavável a 30°.
 %100 akrilik elyaf boyalı iplik. Leke itici, küf önleyici ile muamele edilmiş. Işık hızlığı 5/8. Çıkarılabilir/fermuar, 30°de yıkanabilir.
 Акриловое волокно 100% окрашенное в пряже. Пятноустойчивая и противоплесневая обработка. Светостойкость 5/8. Съемная обивка/с молнией, стирать при 30°.



durelTOP



DurelTOP è un sistema innovativo di produzione di piani per tavoli studiati per raggiungere i più elevati livelli di praticità, resistenza, robustezza ed eleganza. I piani DurelTOP sono ad alto spessore, formati da un doppio strato tumburato perfettamente chiuso. Prodotti in polipropilene di prima qualità, sono inalterabili all'acqua, resistenti al sole e facili da pulire. DurelTOP è il risultato di una lunga ricerca tecnologica e dell'esperienza decennale nella lavorazione delle materie plastiche della NARDI, da sempre all'avanguardia nell'ambiente contract e giardino.

The DurelTOP is an innovative new system in the production of tabletops developed to reach the highest levels of practicality, resistance, and elegance. The DurelTOP tabletops have a greater thickness, formed by a double layer enclosure perfectly closed. Produced in first quality polypropylene, they are resistant to water, resistant to sunlight, and are easy to clean. DurelTOP is a result of a decade's long research and development in plastics by Nardi, always a leader in the contract and garden sectors.

DurelTOP est un système innovateur de production de plateaux de tables, il est étudié pour retrouver le meilleur niveau de pratique de résistance et d'élegance. Les plateaux DurelTOP sont très épais, formés de doubles couches parfaitement finies. Ce sont des produits en polypropylène de première qualité, ils sont inaltérables à l'eau, résistants au soleil et faciles à nettoyer. DurelTOP est le résultat d'une longue recherche technologique et une expérience décennale dans le travail des matières plastique de la Sté NARDI, toujours à l'avant-garde dans le secteur du contract et jardin.

DurelTOP ist ein neu entwickeltes System für die Produktion von Tischplatten, um ein Höchstmaß an Funktionalität, Widerstandsfähigkeit und Eleganz zu erreichen. Durch das innen verstärkte "Zwei-Schichten-Hohlraum-System" erreicht die DurelTOP Tischplatte einen stärkeren Querschnitt und damit ein Höchstmaß an Festigkeit. Hergestellt aus hochwertigem Qualitätspolypropylen ist sie resistent gegen Wasser und Sonnenlicht und dabei leicht zu reinigen. DurelTOP ist das Ergebnis von 10 Jahren Forschung und Entwicklung auf dem Kunststoffsektor durch Nardi, immer der führende im Bereich Contract- und Gartenmöbel.

DurelTOP es un nuevo sistema de fabricación de tableros de mesa estudiado para alcanzar los mas altos niveles de practicidad, resistencia, robustez y elegancia. Los tableros DurelTOP de gran solidez, estan formados por una doble capa perfectamente unida y sellada. Fabricados en polipropileno de primera calidad son inalterables al agua, resistentes al sol y de fácil limpieza. DurelTOP es el resultado de una prolongada investigación tecnológica y de la experiencia acumulada en los mas de diez años que Nardi lleva produciendo materias plasticas, siempre innovando en ambientes contract y jardin.

DurelTOP é um sistema de inovação da produção de tampos de mesa concebidos para atingir a máxima resistência, práticos e elegantes. Os tampos de mesa DurelTOP são formados por uma camada dupla e perfeitamente unida. Produzidos em polipropileno de primeira qualidade, são resistentes ao sol e fáceis de limpar. DurelTOP é o resultado de uma longa investigação tecnológica em materiais plásticos da Nardi, leader em mobiliário de jardim.

DurelTOP, masa tablalarının üretiminde kullanılan yeni bir sistem olup, yüksek seviyede pratiklik, direnç ve de şıklık sunmak amacıyla geliştirilmiştir. DurelTOP masa tablaları fevkalade bir inceliğe sahip olup, kusursuz kapanan çift tabaka çevirme sistemiyle oluşturulmuştur. Nitelikli çamsakızından üretilmiş olup, suya ve güneş ışığına karşı dirençli ve temizlenmesi kolaydır. DurelTOP sistemini Contract ve de Bahçe sektöründe her zaman lider olan Nardi'nin uzun araştırmalarının sonucundan doğan, plastikte gelişim olarak adlandırabiliriz.

DurelTOP — это инновационная система производства столешниц, позволяющая изготавливать практичные, прочные, крепкие и элегантные столешницы. Столешницы DurelTOP обладают высокой плотностью и состоят из двойной панели с мелкопустотным заполнением, полностью закрытой. Изделия из полипропилен высокого качества устойчивы к воде, солнцу и просты в уходе. DurelTOP — это результат многолетних технологических исследований и десятилетнего опыта NARDI в обработке пластмасс, лидера в производстве садовой мебели и контрактном секторе.

tessuto 100% Olefin



100% Olefin tinto in massa. Trattamento antimacchia, antimuffa. Solidità alla luce 7/8.
 Sfoderabile/zip, lavabile a 40°.
 100% Olefin mass dyed. Dirt repellent and anti-mould treatment. 7/8 light fastness.
 Removeable/zip, washable at 40°.
 100% Olefin teintée en masse. Traitement anti-taches et anti-moisissure. Résistance à la lumière 7/8. Déhoussable/zip. Lavable à 40°.
 100% fasergefärbtes Olefin. Gegen Flecken und Schimmel Behandlung. Lichtechtheit 7/8. Abziehbarer/zip. Waschbar bei 40°.

100% Olefin tintada en masa. Protección antimanchas, antimoho. Solidez a la luz 7/8. Desenfundable/zip. Lavable a 40°.
 100% Olefin tingida em massa. Tratamento antimancha e antimoho. Resistência à luz 7/8. Removível/zip. Lavável a 40°.
 %100 Olefin çözelti halindeyken boyanmış. Leke itici, küf önleyici ile muamele edilmiş. Işık hızlığı 7/8. Çıkarılabilir/fermuar, 40°de yıkanabilir.
 100% Olefin, окрашенный в массе. Пятноустойчивая и противоплесневая обработка. Светостойкость 7/8. Съемная обивка/с молнией, стирать при 40°.



tessuto acrilico stampato



Fibra acrilica 100% stampa digitale. Solidità alla luce 6. Sfoderabile/zip, lavabile a 30°. 100% acrylic fiber with digital print. 6 light fastness. Removeable/zip, washable at 30°. 100% fibre acrylique impression numérique. Résistance à la lumière 6. Déhoussable/zip. Lavable à 30°. 100% Acrylfaser mit Digitaldruck. Lichtechtheit 6. Abziehbarer/zip. Waschbar bei 30°.

100% fibra acrílica impresión digital. Solidez a la luz 6. Desenfundable/zip. Lavable a 30°. 100% fibra acrílica estampa digital. Resistência à luz 6. Removível/zip. Lavável a 30°. %100 dijital baskı akrilik elyaf. Işığa dayanıklılık 6. Çıkarılabilir kılıf/fermuar, 30°de yıkanabilir. 100% акриловое волокно с цифровым рисунком, окрашенное в процессе производства. Светостойкость 6. Съемная ткань/на молнии, стирка при 30°.



tropical .081
190 gr/m²

tessuto acrilico Sunbrella®



100% fibra acrilica SUNBRELLA® tinto in massa. Trattamento idrorepellente, antimacchia, antimuffa. Solidità alla luce 8/8. Sfoderabile/zip, lavabile a 40°. 100% SUNBRELLA® acrylic fiber mass dyed. Water repellent treatment, dirt repellent and anti-mould treatment. 8/8 light fastness. Removeable/zip, washable at 40°. 100% fibre acrylique SUNBRELLA® teintée en masse. Traitement imperméable, anti-taches et anti-moisissure. Résistance à la lumière 8/8. Déhoussable/zip. Lavable à 40°. 100% fasergefärbtes Acryl SUNBRELLA®. Wasserabweisend Behandlung, gegen Flecken und Schimmel Behandlung. Lichtechtheit 8/8. Abziehbarer/zip. Waschbar bei 40°.

100% fibra acrílica SUNBRELLA® tintada en masa. Tratamiento por la repelencia al agua, protección antimanchas, antimoho. Solidez a la luz 8/8. Desenfundable/zip. Lavable a 40°. 100% fibra acrílica SUNBRELLA® tingida em massa. Tratamento hidrorrepelente, antimancha e antimofa. Resistência à luz 8/8. Removível/zip. Lavável a 40°. %100 akrilik elyaf SUNBRELLA® çözültü halindeyken boyanmış. Su itici, leke itici, küf önleyici ile muamele edilmiş. Işık haslıđı 8/8. Çıkarılabilir/fermuar, 40°de yıkanabilir. 100% акриловое волокно SUNBRELLA®, окрашенное в массе. Водоотталкивающая, пятноустойчивая и противогрибковая обработка. Светостойкость 8/8. Съемная обивка/ молнией, стирать при 40°.



grigio Sunbrella® .136
275 gr/m²



canvas Sunbrella® .141
275 gr/m²



adriatic Sunbrella® .142
260 gr/m²

imbottitura

CUSCINO NET BENCH - CUSCINO NET RELAX - CUSCINO NET - CUSCINO FIT ARIA

Poliuretano espanso. Densità 28 kg/m³. Polyurethane foam. Density 28 kg/m³. Mousse polyuréthane. Densité 28 kg/m³. Polyurethanschaum. Dichte 28 kg/m³. Espuma de poliuretano. Densidad 28 kg/m³. Espuma de poliuretano. Densidade 28 kg/m³. Poliüretan köpük. Yoğunluk 28 kg/m³. Пенополиуретан. Плотность 28 кг/м³.

CUSCINO SEDUTA ARIA

Poliuretano espanso. Densità 25 kg/m³. Polyurethane foam. Density 25 kg/m³. Mousse polyuréthane. Densité 25 kg/m³. Polyurethanschaum. Dichte 25 kg/m³. Espuma de poliuretano. Densidad 25 kg/m³. Espuma de poliuretano. Densidade 25 kg/m³. Poliüretan köpük. Yoğunluk 25 kg/m³. Пенополиуретан. Плотность 25 кг/м³.

CUSCINO SHELL NET RELAX

Poliuretano espanso su struttura rigida di polipropilene. Densità 70 kg/m³. Polyurethane foam over solid polypropylene frame. Density 70 kg/m³. Mousse polyuréthane sur structure rigide de polypropylène. Densité 70 kg/m³. Polyurethanschaum auf steifer Polypropylen-gestell. Dichte 70 kg/m³. Espuma de poliuretano sobre estructura rígida de polipropileno. Densidad 70 kg/m³. Espuma de poliuretano sobre estrutura rígida de polipropileno. Densidade 70 kg/m³. Sert polipropilen gövde üzerinde poliüretan köpük minder. Yoğunluk 70 kg/m³. Пенополиуретан на жесткой конструкции из полипропилена. Плотность 70 кг/м³.

CUSCINO PASSEPARTOUT

Fibra di poliestere. Polyester fiber. Fibre de polyester. Polyesterfasern. Fibras de poliéster. Fibras de poliéster. Polyester elyaf. Обивка из полиэстера.

CUSCINO SEDUTA KOMODO - CUSCINO ARREDO ARIA

Poliuretano espanso (densità 25 kg/m³) rivestito da fibra di poliestere (densità 450 gr/m²). Polyurethane foam (density 25 kg/m³) with polyester fiber (density 450 gr/m²). Mousse polyuréthane (densité 25 kg/m³) avec fibres de polyester (densité 450 gr/m²). Polyurethanschaum (Dichte 25 kg/m³) mit Polyesterfasern beschichtet (Dichte 450 gr/m²). Espuma de poliuretano (densidad 25 kg/m³) cubierta con fibras de poliéster (densidad 450 gr/m²). Espuma de poliuretano (densidade 25 kg/m³) com cobertura fibras de poliéster (densidade 450 gr/m²). Polyester elyaf (Yoğunluk 450 gr/m²) kaplı köpük poliüretan (Yoğunluk 25 kg/m³). Пенополиуретан (Плотность 25 кг/м³) с покрытием из обивка из полиэстера (Плотность 450 гр/м²).

CUSCINO SCHIENALE KOMODO - CUSCINO SCHIENALE ANGOLO KOMODO

Poliuretano espanso (densità 21 kg/m³) rivestito da fibra di poliestere (densità 450 gr/m²). Polyurethane foam (density 21 kg/m³) with polyester fiber (density 450 gr/m²). Mousse polyuréthane (densité 21 kg/m³) avec fibre de polyester (densité 450 gr/m²). Polyurethanschaum (Dichte 21 kg/m³) mit Polyesterfasern beschichtet (Dichte 450 gr/m²). Espuma de poliuretano (densidad 21 kg/m³) cubierta con fibras de poliéster (densidad 450 gr/m²). Espuma de poliuretano (densidade 21 kg/m³) com cobertura fibras de poliéster (densidade 450 gr/m²). Polyester elyaf (Yoğunluk 450 gr/m²) kaplı köpük poliüretan (Yoğunluk 21 kg/m³). Пенополиуретан (Плотность 21 кг/м³) с покрытием из обивка из полиэстера (Плотность 450 гр/м²).

tessuto sintetico

Tessuto in filo di poliestere rivestito in pvc. Fabric is made of a polyester fiber, with a pvc coating. Tissu en fil de polyester revêtu de pvc. Gewebe aus PVC-ummantelten Polyesterfasern.

Tejido en hilo de poliéster recubierto de pvc. Tecido de fibra polyester com cobertura pvc. PVC kaplı polyester elyaf tekstil. Ткань из полиэфирных нитей с покрытием из ПВХ.

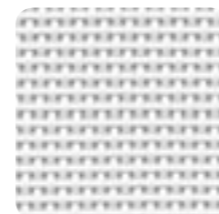

bianco .107
tela 1x1



tortora .104
tela 1x1

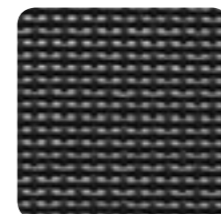

antracite .057
tela 1x1

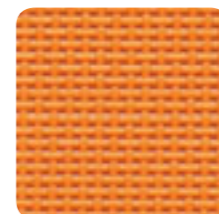

mandarino .083
tela 1x1

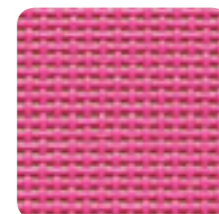

rosa .056
tela 1x1

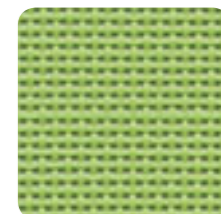

prato .084
tela 1x1

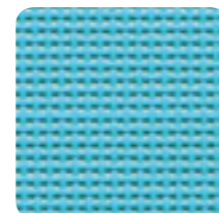

celeste .075
tela 1x1



blu .102
tela 1x1

alluminio verniciato

La verniciatura è a polvere di poliestere.
The painting is with polyester powder.
La peinture est à poudre de polyester.
Die Epoxierung erfolgt mit Polyesterpulver.

El pintado se realiza con polvo de poliéster.
O pó de poliéster é usado para envernizar.
Boyası polyester tozla yapılır.
Окраска производится при помощи порошкового полиэстера.



verniciato bianco .53



verniciato tortora .59



verniciato caffè .57



verniciato antracite .52

vetro sp. 10 mm

Vetro float temperato serigrafato e vetrificato a 700°C.
Tempered Float glass, screen-printed and vitrified at 700° C.
Verre float trempé sérigraphié et vitrifié à 700°C.
Sicherheitsglas mit innenliegendem Dekorsiebdruck, verglast bei 700°.

Vidrio float, templado, serigrafiado y vetrificado a 700°C.
Vidro float temperado, impresso e vitrificado a 700°C.
Temperli, üstü baskılı ve 700° C vitrifiye edilmiş.
Сериграфированное закаленное стекло float, производимое при 700°C.



BIANCO .00



ANTRACITE .02

laminato HPL sp. 12 mm

Laminato decorativo ad alta pressione, compatto, omogeneo, non poroso, ad alta densità.
Decorative high pressure laminate, solid, homogeneous, non-porous and with a high density.
Stratifié décoratif à haute pression, condensé, homogène, pas poreux, haute densité.
HPL-laminat, beständig, homogen, hoch verdichtet.

Laminado decorado a alta presión, compacto, homogéneo, no poroso y de alta densidad.
Decorativo e laminado a alta pressão, sólido, homogéneo, não poroso e de grande densidade.
Dekoratif yüksek basınçlı laminat, masif, gözeneksiz ve yüksek yağlınluklu. Декоративный ламинат высокого давления, компактный, однородный, непористый, с высокой плотностью.



BIANCO .301



ANTRACITE .303



impilabile stackable empilable stapelbar apilable empilhável istiflenebilir стекируемые



reclinabile reclining dossier réglable verstellbare Rückenlehne reclinable reclinável sırt pozisyonlu откидной

Tutte le sedute sono dotate di piedini antiscivolo. All chairs are equipped with non-slip rubber feet. Tous les sièges sont équipés avec embouts anti-dérapants.
Alle Stühle sind mit rutschfesten Fußkappen ausgestattet. Todos los asientos están equipados con tacos antideslizantes. Todos os assentos estão equipados com pés anti-derrapantes.
Bütün sandalyeler kaymaz ayaklıdırlar. Ножки всех стульев оснащены противоскользящей резиновой подложкой.

Sui colori scuri, ombre ed altri difetti minori sono più evidenti rispetto ai colori chiari e sono da ritenersi standard. On dark colors, shadows and other minor faults are more evident than on lighter colors and are therefore standard. Sur les couleurs sombres, les ombres et les autres petits défauts sont plus marqués que sur les couleurs claires et sont tout à fait standards. Auf dunklen Farben sind Schatten und andere kleinere Mängel sichtbar als auf hellen Farben und sind daher als Standard zu betrachten. Las sombras y demás defectos menores son más evidentes sobre los colores oscuros respecto a los colores claros y tienen que considerarse como estándares. Em cores escuras, sombras e outros defeitos menores são mais evidentes do que em cores claras e devem ser considerados standard. Koyu renkler üzerinde, gölgeler ve diğer küçük defolar açık renkler üzerinde olduklarından daha belirginleşmekte ve bu nedenle normal olarak değerlendirilmelidirler. По сравнению со светлыми цветами на темных цветах тени и другие небольшие дефекты более заметны и должны считаться нормой.

Il peso (kg), le misure (cm) e i colori riportati sono indicativi. La NARDI si riserva il diritto di apportare modifiche o varianti senza preavviso. Tutti i modelli sono depositati. Weights (kg), dimensions (cm) and colors are indicative only. NARDI reserves the right to make changes or variations without notice. All models are patented. Le poids (kg), les dimensions (cm) et les coloris indiqués sont fournis purement à titre indicatif. La Firma NARDI se réserve le droit d'apporter toute modification ou variation sans aucun préavis. Tous les modèles sont déposés. Alle Farb-, Maß- (cm) und Gewichtsangaben (kg) sind nicht als fest bindend anzusehen. Firma NARDI behält sich das Recht von Änderungen. Alle Modelle sind gesetzlich geschützt. El peso (kg), las medidas (cm) y los colores detallados, son indicativos. La firma NARDI se reserva el derecho de modificaciones o variaciones sin previo aviso. Todos los modelos llevan nuestra marca. O peso (kg), as medidas (cm) e as cores indicadas, são indicativas. A NARDI reservase o direito de aportar modificações ou variações sem préaviso. Todos os modelos estão depositados. Ağırlık (Kg), boyutlar (cm) ve renkler gösterme amaçlıdır. NARDI'nin önceden bildirmeden değişiklik yapma hakkı vardır. Bütün modeller patentlidir. Приведенный вес (кг), размеры (см) и цвета являются ориентировочными. Компания NARDI оставляет за собой права вносить изменения и вариации без предварительного предупреждения. Все модели зарегистрированы.

STYLING
Elisa Musso

PHOTO
studio Raffaello Galiotto

THANKS TO

AYTM
Bitossi Home
Bloomingville
Ichendorf
Incipit Lab
L'Abitare
Normann Copenaghen

NARDI s.p.a.
Chiampo (VI) Italy
tel. +39 0444 422100
info@nardioutdoor.com
www.nardioutdoor.com

